

Castors, Legs & Glides



- high quality furniture fittings



The technical descriptions and dimensions in this catalogue, also those with the photographs and drawings, are not binding. We reserve the right to make design improvements.

We bear no liability for any misprints or other errors that might occur in the production of the catalogue.

SISO A/S tager forbehold for trykfejl samt ændringer i produktets specifikationer.

Für Druckfehler und Irrtümer ist jede Haftung ausgeschlossen. Produktänderungen behalten wir uns vor.



- high quality furniture fittings

SISO A/S
MILEPARKEN 11
DK - 2740 SKOVLUNDE
(COPENHAGEN)
DENMARK
PHONE: (+45) 45 830 900
FAX: (+45) 45 830 444

DISTRIBUTOR

CONTENTS

- high quality furniture fittings



CONTENTS	3-4	
TWIN WHEEL CASTORS	5-10	
TEA TROLLEY CASTOR "FORCELLA"	11	
FORK CASTORS W/TOP PLATE & PU WHEEL	12-14	
FORK CASTORS W/TOP PLATE & ALU WHEEL	15-17	
BOX CASTORS	18-20	
BRASS CASTOR "BRASCELLA"	21	
FORK CASTOR "GARDA" - Ø76 MM	22	
FORK CASTORS W/TOP PL. & PU TRACK - STEEL	23-28	
INDUSTRIAL FORK CASTOR W/SWIVEL TOP PL.	29	
CHOOSE THE RIGHT CASTOR	30	
ALU & STEEL LEGS	31-32	
TABLE METAL LEGS W/HEIGHT ADJUSTER	33	
"TWISTER" & "MINI TWISTER" - THE LEG CONNECTORS	34-36	
"TWIST 'N TURN" - THE LEG CONNECTOR	37	

"RIMA" THE LEG CONNECTOR F/SQUARE LEGS	38-39	
ADJUSTABLE GLIDES	40-49	
PANEL SHOES	50	
NAIL-ON GLIDES	51-53	
KNOCK-IN GLIDES & FELT PADS	53-54	
BUMPER DISCS & SUCTION PADS	55	
SUCTION PADS & TUBE SLIDES	56	
TUBE SLIDES	57	
WASHERS & SPACERS	58	
INSERT GLIDES	59-62	

TWIN WHEEL CASTOR W/TOP PLATE

- high quality furniture fittings



TWIN WHEEL CASTOR W/TOP PLATE

Material: Wheel: Polyamid (PA), black.
Top plate: 2 mm steel, bright zinc plated.

Application: Premounted top plate 42 x 42 mm or
38 x 38 mm.

With or without brake.



No brake



mm



mm

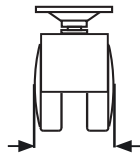

mm



static
kg

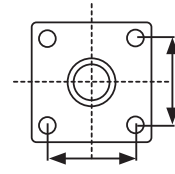

mm

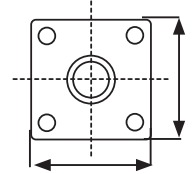

mm

08.04.003

30

43

32

15

25 x 25

38 x 38 x 2

08.04.029

40

56

41

25

32 x 32

42 x 42 x 2

08.04.097

50

64

47

30

32 x 32

42 x 42 x 2



With brake



mm



mm

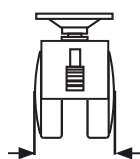

mm



static
kg

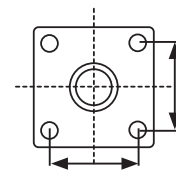

mm

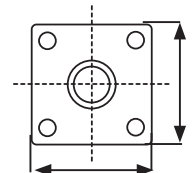

mm

08.04.005

30

43

32

15

25 x 25

38 x 38 x 2

08.04.028

40

56

41

25

32 x 32

42 x 42 x 2

08.04.096

50

64

47

30

32 x 32

42 x 42 x 2

TWIN WHEEL CASTOR W/KNOCK-IN SOCKET & W/NYLON SOCKET



TWIN WHEEL CASTOR W/KNOCK-IN SOCKET

Material: Wheel: Polyamid (PA), black.
 Knock-in socket: Polyamid (PA), black.

Application: Knock-in socket $\varnothing 12 \times 12$ mm
 (Not premounted).

Without brake.



No brake



mm

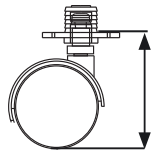

mm

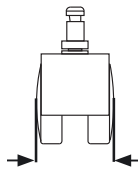

mm



static
kg



mm

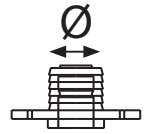

mm

08.04.001

30

43

32

15

12

12

TWIN WHEEL CASTOR W/NYLON SOCKET



Material: Wheel: Polyamid (PA), black.
 Socket: Polyamid (PA), black.

Application: Knock-in socket $\varnothing 10,5 \times 30$ mm
 (not premounted).

Knock-in hole depth 33 mm

Without brake.



No brake



mm

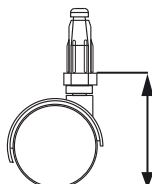

mm



mm



static
kg



mm

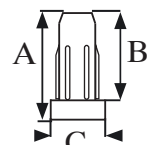

mm

08.04.002

30

49

29

15

10,5

A

B

C

33

28

15,5

08.04.017

50

65

47

30

10,5

33

30

15,5

TWIN WHEEL CASTOR W/THREADED STEM

- high quality furniture fittings



TWIN WHEEL CASTOR W/THREADED STEM

Material: Wheel: Polyamid (PA), black.
 Threaded stem: Steel, bright zinc plated.

Application: Premounted threaded stem in M8 & M10.
 With or without brake.



No brake



mm

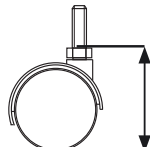

mm

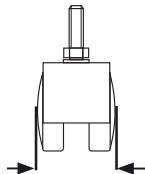

mm



static
kg



mm

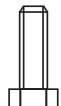

M

08.04.031
 # 08.04.105
 # 08.04.116

40
 50
 50

51
 60
 60

37
 45
 45

25
 30
 30

15
 15
 15

8
 8
 10



With brake



mm

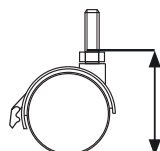

mm

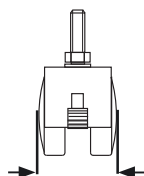

mm



static
kg

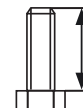

mm

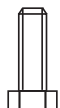

M

08.04.030
 # 08.04.110
 # 08.04.118

40
 50
 50

51
 60
 60

37
 45
 45

25
 30
 30

15
 15
 15

8
 8
 10

TWIN WHEEL CASTOR W/U-BRACKET

TWIN WHEEL CASTOR W/U-BRACKET

Material: Wheel: Polyamid (PA), black.
 U-bracket : Steel, black zinc plated.

Application: Premounted U-bracket for 16 mm panel.
 With M 4 x 22 mm screw.

Without or without brake.



No brake



mm

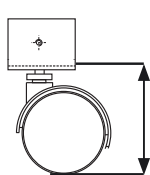

mm

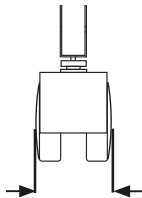

mm



static
kg



mm

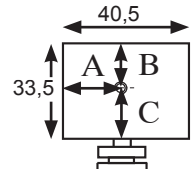

mm

08.04.032

40

56

41

25

16

A	B	C
20,25	7,5	26



With brake



mm

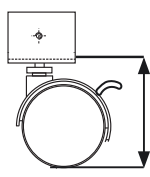

mm

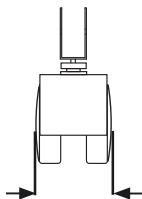

mm



static
kg



mm

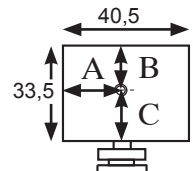

mm

08.04.033

40

56

41

25

16

A	B	C
20,25	7,5	26

TWIN WHEEL CASTOR "LECCO" W/PU TRACK - Ø 50 MM

Material: Wheel hood & core: Polyamid (PA), black.
Wheel track: Polyurethane (PU), grey.
Top plate: 2 mm steel, bright zinc plated.

Application: Premounted top plate 42 x 42 mm.
Hole distance (c/c.) : 32 mm, Ø5 mm screw holes.
Recommended for hard surface.
Without brake.



mm

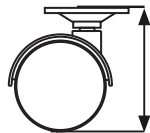

mm

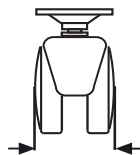

mm

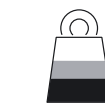

static/dynamic
kg

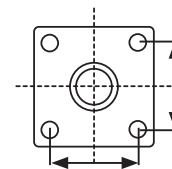

mm

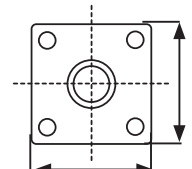

mm

08.04.099

50

65

45

50/30

32 x 32

42 x 42 x 2

TWIN WHEEL CASTOR "BARI" W/PU TRACK - Ø 65 MM

TWIN WHEEL CASTOR "BARI" W/PU TRACK - Ø 65 MM



Material: Wheel hood & core: Polypropylene (PP), grey.
Wheel track: Polyurethane (PU), black.
Top plate: 2 mm steel, bright zinc plated.

Application: Premounted top plate 42 x 42 mm.
Hole distance (c/c.) : 32 mm, Ø5 mm screw holes.
Recommended for hard surface.
With or without brake.



mm

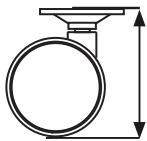

mm

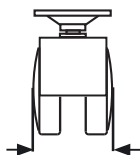

mm

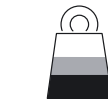

static/dynamic
kg

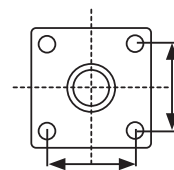

mm

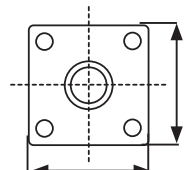

mm

08.04.200

65

78

45

80/50

32 x 32

42 x 42 x 2



mm



mm

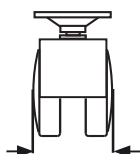

mm

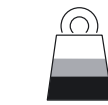

static/dynamic
kg

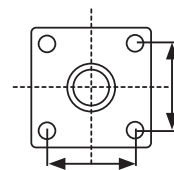

mm

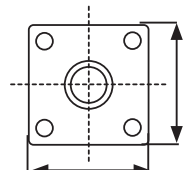

mm

08.04.201

65

78

45

80/50

32 x 32

42 x 42 x 2

TEA TROLLEY CASTOR "FORCELLA"

- high quality furniture fittings



TEA TROLLEY CASTOR "FORCELLA"

Material: Steel: Brass (BPL) or nickel Pl. (NPL).
Wheel: Polyamid (PA), black.

Application: Metal socket $\varnothing 7 \times 35$ mm with black plastic bushing.



FINISH



mm

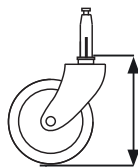

mm



mm



static
kg



mm

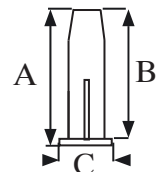

mm

						\varnothing	A	B	C
# 08.01.084	BPL	38	46	8	9	10	30	17	28
# 08.01.110	NPL	75	86	11	15	10	30	17	28

FORK CASTOR W/TOP PLATE & TRANSPARENT PU WHEEL

FORK CASTOR W/TOP PLATE & TRANSPARENT PU WHEEL

Material: Wheel track: Polyurethane (PU), transparent.
 Wheel body: Polyurethane (PU), transparent.
 Top plate: 1,8 mm steel, zinc plated.

Application: With premounted top plate 50 x 50 mm.
 Recommended for hard surface.
 With or without plastic brake.

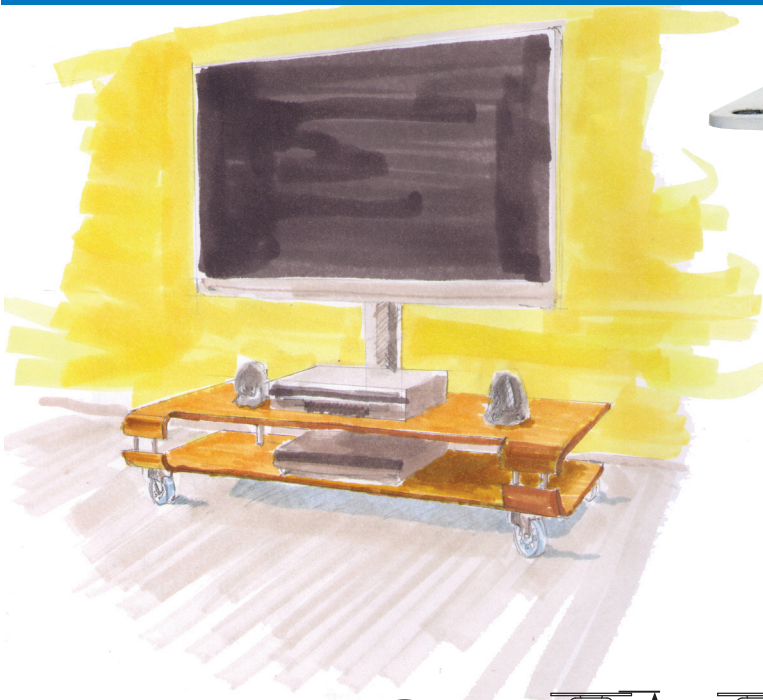

No brake



mm



mm



mm



static
kg

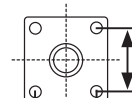

mm

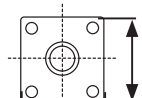

mm



With brake



mm

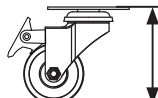

mm



mm



static
kg

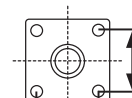

mm



mm

# 08.12.290	35	51	20	25	38 x 38	50 x 50 x 1,8
# 08.12.300	50	65	20	50	38 x 38	50 x 50 x 1,8
# 08.12.310	75	90	23	70	38 x 38	50 x 50 x 1,8

# 08.12.291	35	51	20	25	38 x 38	50 x 50 x 1,8
# 08.12.301	50	65	20	50	38 x 38	50 x 50 x 1,8
# 08.12.311	75	90	23	70	38 x 38	50 x 50 x 1,8

FORK CASTOR W/TOP PLATE & COLORED TRANSPARENT PU WHEEL

- high quality furniture fittings



Transparent Orange

Ø50 mm # 08.12.308
Ø75 mm # 08.12.318

Transparent Orange with brake

Ø50 mm # 08.12.309
Ø75 mm # 08.12.319



Transparent Black

Ø35 mm # 08.12.292
Ø50 mm # 08.12.302
Ø75 mm # 08.12.312

Transparent Black with brake

Ø35 mm # 08.12.293
Ø50 mm # 08.12.303
Ø75 mm # 08.12.313



Transparent Green

Ø50 mm # 08.12.306
Ø75 mm # 08.12.316

Transparent Green with brake

Ø50 mm # 08.12.307
Ø75 mm # 08.12.317



Transparent Blue

Ø50 mm # 08.12.304
Ø75 mm # 08.12.314

Transparent Blue with brake

Ø50 mm # 08.12.305
Ø75 mm # 08.12.315

FORK CASTOR "SPIKE" Ø50 MM & Ø75 MM

FORK CASTOR "SPIKE" Ø50 & Ø75 MM

Material:

Wheel track: Polyurethane (PU), transparent or black
 Wheel body: Polyurethane (PU), transparent or black
 Top plate: 1,8 mm steel, zinc plated.

Application: With premounted top plate 50 x 50 mm.
 Recommended for hard surface.
 With or without plastic brake.

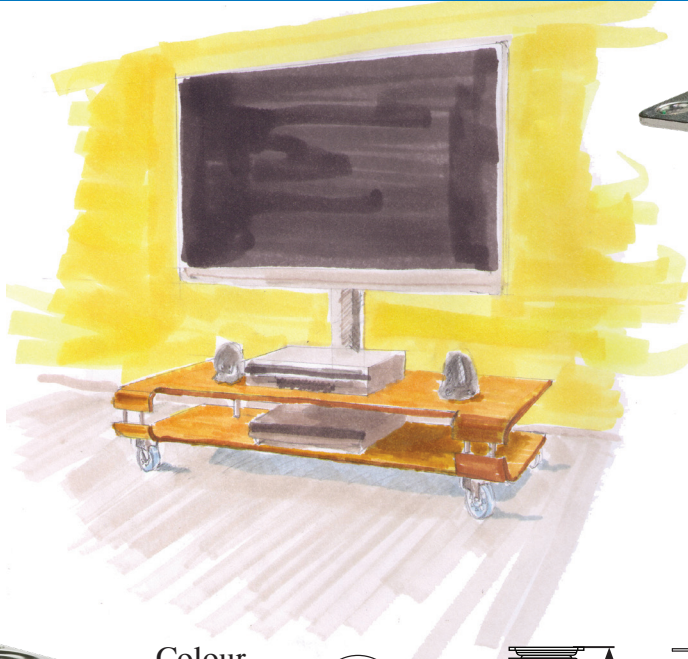

No brake

Colour of wheel



mm



mm

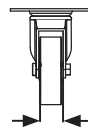

mm



static kg

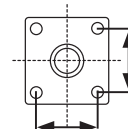

mm

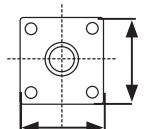

mm

# 08.12.330	Black	50	64	16	35	38 x 38	50 x 50 x 1,8
# 08.12.332	Transparent	50	64	16	35	38 x 38	50 x 50 x 1,8
# 08.12.334	Black	75	91	20	45	38 x 38	50 x 50 x 1,8
# 08.12.336	Transparent	75	91	20	45	38 x 38	50 x 50 x 1,8



With brake

Colour of wheel



mm



mm

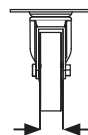

mm



static kg

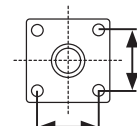

mm

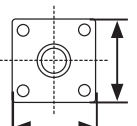

mm

# 08.12.331	Black	50	64	16	35	38 x 38	50 x 50 x 1,8
# 08.12.333	Transparent	50	64	16	35	38 x 38	50 x 50 x 1,8
# 08.12.335	Black	75	91	20	45	38 x 38	50 x 50 x 1,8
# 08.12.337	Transparent	75	91	20	45	38 x 38	50 x 50 x 1,8

FORK CASTOR "JAC" Ø50 MM & Ø75 MM

- high quality furniture fittings



FORK CASTOR "JAC" Ø50 & Ø75 MM

Material:

Wheel track: Polyurethane (PU), Black ring
 Wheel body: Bright Anodized Aluminum
 Fork: Chrome Pl. Steel Fork
 Top plate: 2 mm steel, zinc plated.

Application: With premounted top plate 42 x 42 mm or 60 x 60 mm.
 Recommended for hard surface.
 With or without plastic brake.

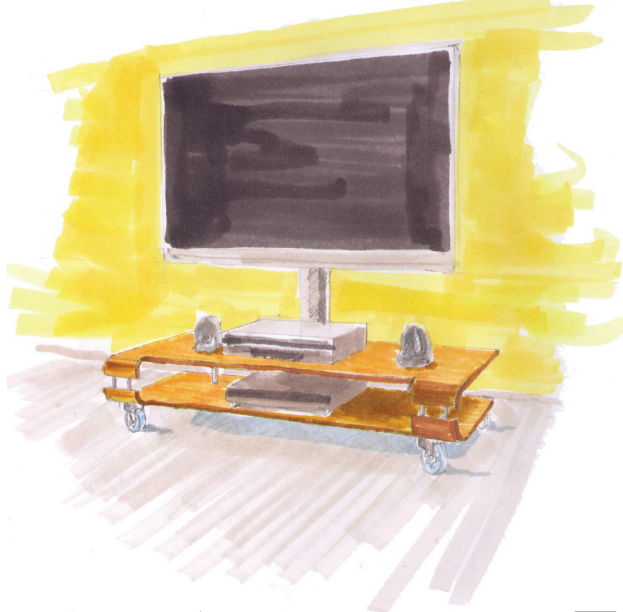

No brake

Colour of wheel track



mm

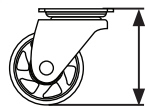

mm

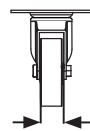

mm



static
kg

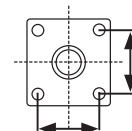

mm

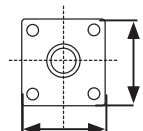

mm

08.12.350

Black PU

50

65

20

40

32 x 32

42 x 42 x 2

08.12.355

Black PU

75

98

24

50

44 x 44

60 x 60 x 2



With brake

Colour of wheel track



mm



mm

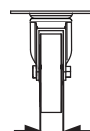

mm



static
kg

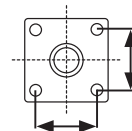

mm

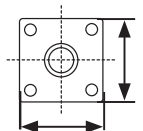

mm

08.12.351

Black PU

50

65

20

40

32 x 32

42 x 42 x 2

08.12.356

Black PU

75

98

24

50

44 x 44

60 x 60 x 2

FORK CASTOR "BOB" Ø50 MM & Ø75 MM

FORK CASTOR "BOB" Ø50 & Ø75 MM

Material:

Wheel track: Polyurethane (PU), Black ring
 Wheel body: Matt Anodized Aluminum
 Fork: Alu finish, Steel Fork
 Top plate: 2 mm steel, zinc plated.

Application: With premounted top plate 42 x 42 mm or 60 x 60 mm.
 Recommended for hard surface.
 With or without plastic brake.

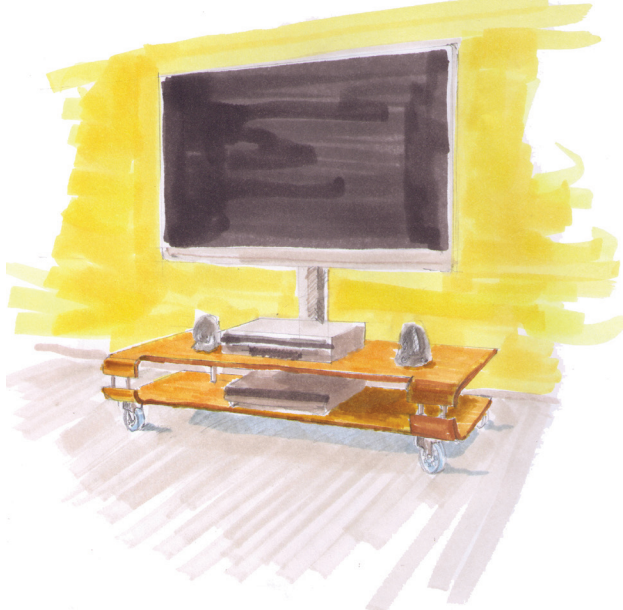

No brake

Colour of wheel track



mm

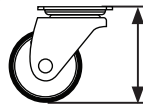

mm

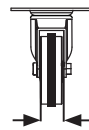

mm



static
kg

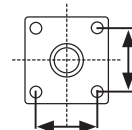

mm

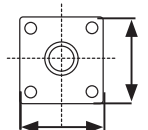

mm

08.12.360

Black PU

50

65

20

40

32 x 32

42 x 42 x 2

08.12.365

Black PU

75

98

24

45

44 x 44

60 x 60 x 2



With brake

Colour of wheel track



mm



mm

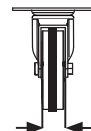

mm



static
kg

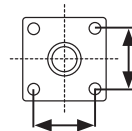

mm

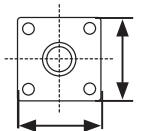

mm

08.12.361

Black PU

50

65

20

40

32 x 32

42 x 42 x 2

08.12.366

Black PU

75

98

24

45

44 x 44

60 x 60 x 2

FORK CASTOR "KIKI" Ø50 MM & Ø75 MM

- high quality furniture fittings



FORK CASTOR "KIKI" Ø50 & Ø75 MM

Material:

Wheel track: Polyurethane (PU), Black ring
 Wheel body: MattAnodized Aluminum
 Fork: Alu finish, Steel Fork
 Top plate: 2 mm steel, zinc plated.

Application: With premounted top plate 42 x 42 mm or 60 x 60 mm.
 Recommended for hard surface.
 With or without plastic brake.



No brake

Colour of wheel track



mm



mm



mm



static kg

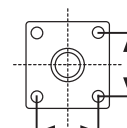

mm

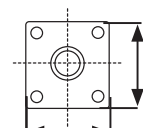

mm

08.12.370
 # 08.12.375

Black PU
 Black PU

50
 75

65
 98

20
 24

40
 45

32 x 32
 44 x 44

42 x 42 x 2
 60 x 60 x 2



With brake

Colour of wheel track



mm



mm

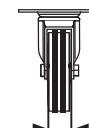

mm



static kg

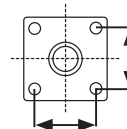

mm

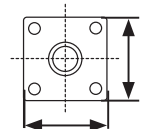

mm

08.12.371
 # 08.12.376

Black PU
 Black PU

50
 75

65
 98

20
 24

40
 45

32 x 32
 44 x 44

42 x 42 x 2
 60 x 60 x 2

BOX CASTOR - SCREW-ON W/ PP WHEEL

Material: Wheel: Polypropylene (PP), white or black.
 Mounting bracket: Steel, bright zinc plated.

Application: Mounting bracket: 19 x 42 mm.
 Hole distance (c/c): 32 mm.

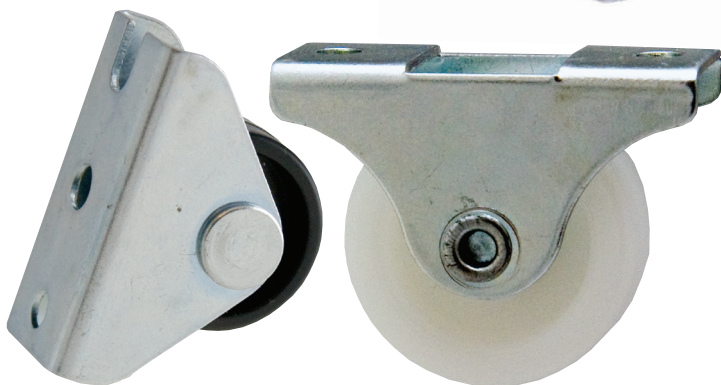

Colour of wheel



mm

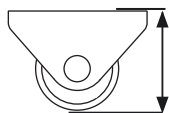

mm



mm



static kg

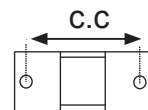

mm

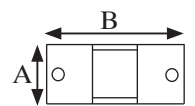

mm

							A B
# 08.06.010	White	25	27	13	25	32	18/40
# 08.06.027	Black	25	28	11	25	32	18/42
# 08.06.025	White	30	33	16	25	32	21/48

BOX CASTOR - W/ PU TRACK

Material: Wheel track: Polyurethane (PU), grey.
 Wheel core: Polypropylene (PP), black (Blk).
 Mounting bracket: Steel, bright zinc plated.

Application: Mounting bracket: 19 x 42 mm or 20 x 58 mm.
 Hole distance (c/c): 32 mm or 46 mm.
 Recommended for hard surface.

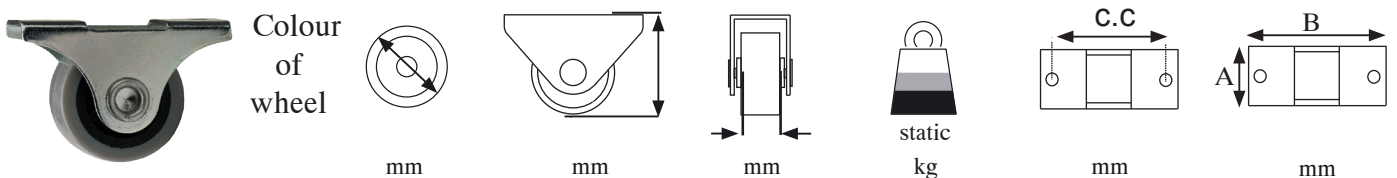

	Colour of wheel	mm	mm	mm	static kg	mm	mm
# 08.06.040	Grey/Blk	25	28	13	25	32	A B 19/42
# 08.06.042	Grey/Blk	32	39	16	25	46	20/58
# 08.06.044	Grey/Blk	40	43	16	25	46	20/58

BOX CASTOR - INLAY TYPE

BOX CASTOR - INLAY TYPE

Material:	Wheel:	Polyamid (PA), black.
	Mounting ring:	Steel, bright zinc plated.
Mounting ring:		Ø26 x 1,5 mm.
Hole distance(c/c):		20 mm.
Application:		Inlay type, ideal for table legs.

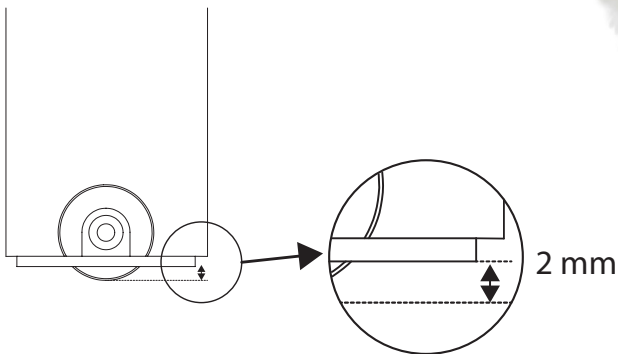

mm

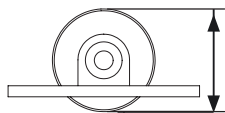

mm

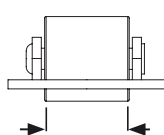

mm



static/dynamic
kg

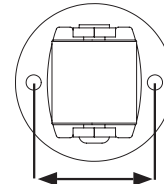

mm

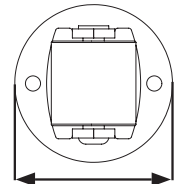

mm

08.06.050

Ø2,5

Ø14 mm

14 mm

30/15

20 mm

Ø26 mm

BRASS CASTOR "BRASCELLA"

- high quality furniture fittings



BRASS CASTOR "BRASCELLA"

Material: Brass: Polished brass.

Application: Mounted by use of steel head F-593 12.09.890-0 & M8 hangerbolt. To be bought separately.

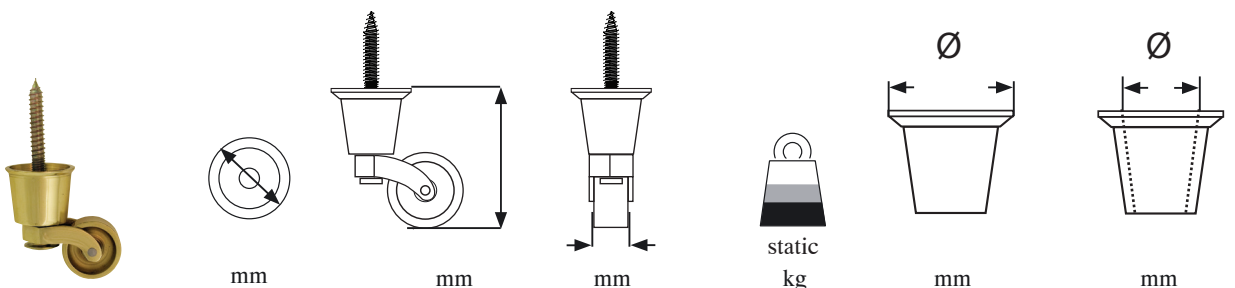
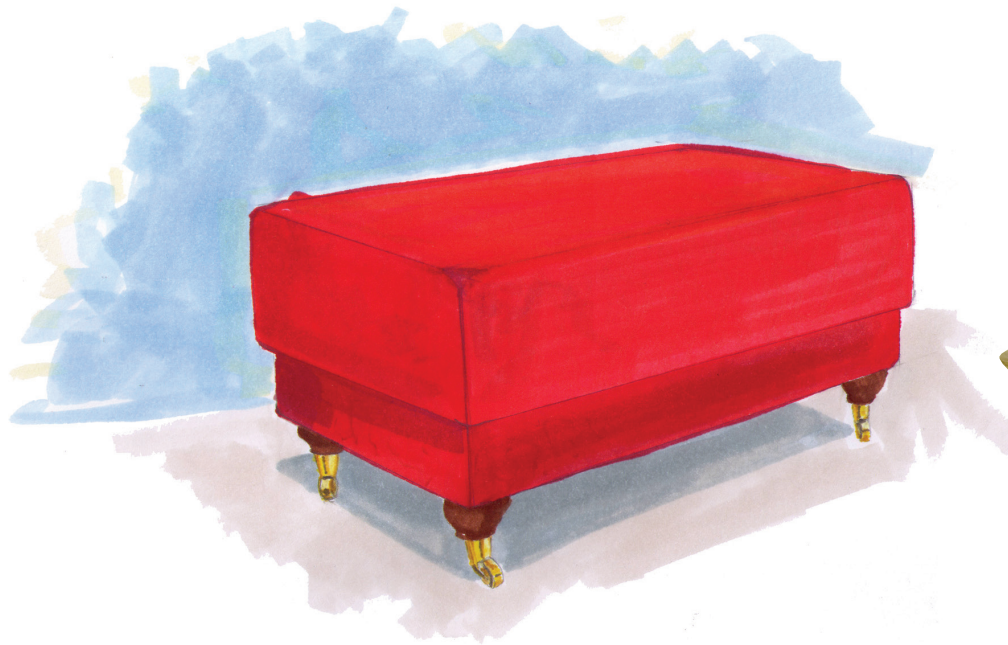
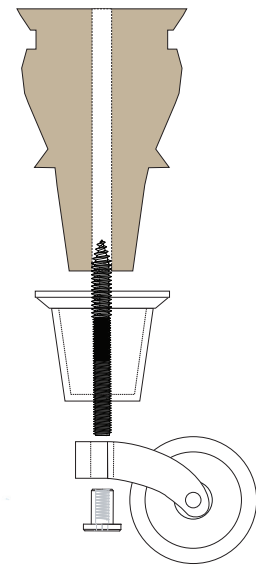

08.05.221

32

65

19

50

39

31,5

FORK CASTOR "GARDA" - Ø76 MM

FORK CASTOR "GARDA" - Ø76 MM



Material: Wheel: Polypropylene (PP), grey.
Metal parts: Steel, bright zinc pl.

Application: Premounted top plate 42 x 42 mm.
Hole distance (c/c.) : 32 mm,
Ø5 mm screw holes.
With or without brake.



No brake



mm



mm



mm



static/dynamic
kg

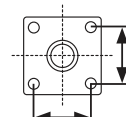

mm

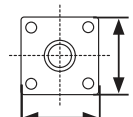

mm

08.12.400

76

100

47

50/25

32 x 32

42 x 42 x 1,5



With brake



mm

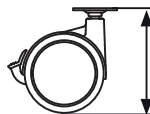

mm



mm



static/dynamic
kg

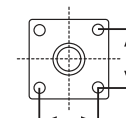

mm

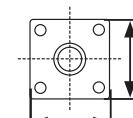

mm

08.12.405

76

100

47

50/25

32 x 32

42 x 42 x 1,5

STEEL FORK CASTOR W/TOP PLATE & PU TRACK



Material: Wheel track: Polyurethane (PU), grey.
Wheel core: Polypropylene (PP), black.
Metal parts: Steel, bright zinc pl.

Application: Premounted top plate.
Recommended for hard surface.
With or without brake.



Fork castor without brake



Fork castor with brake



No brake



mm

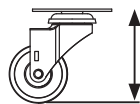

mm

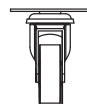

mm



static/dynamic
kg

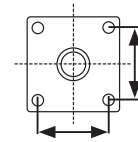

mm

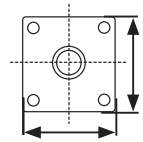

mm

08.12.230

Ø50

66

22

60/35

32 x 32

42 x 42 x 1,5

08.12.232

Ø75

97

23

100/60

45,5 x 45,5

60 x 60 x 2,5



With brake



mm

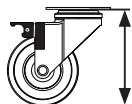

mm

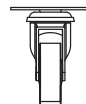

mm



static/dynamic
kg

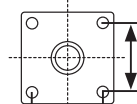

mm

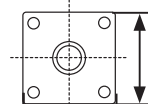

mm

08.12.231

Ø50

66

22

60/35

32 x 32

42 x 42 x 1,5

08.12.233

Ø75

97

23

100/60

45,5 x 45,5

60 x 60 x 2,5

FORK CASTOR W/TOP PL. & RUBBER TRACK

STEEL FORK CASTOR W/TOP PLATE & RUBBER TRACK



Material: Wheel: Grey soft rubber.
Metal parts: Steel, bright zinc pl.

Application: Premounted top plate.
Recommended for hard surface.
With or without brake.



Fork castor without brake



Fork castor with brake



No brake



mm

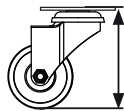

mm

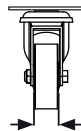

mm



static/dynamic
kg

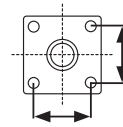

mm

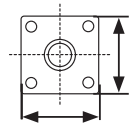

mm



With brake



mm

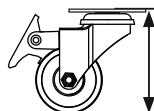

mm

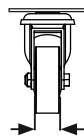

mm



static/dynamic
kg

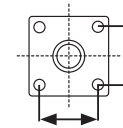

mm

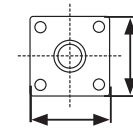

mm

08.12.161

50

72

16

45/30

35 x 35

50 x 50 x 1,5

08.12.163

75

100

21

60/45

45 x 45

65 x 65 x 2

08.12.162

50

72

16

45/30

35 x 35

50 x 50 x 1,5

08.12.164

75

100

21

60/45

45 x 45

65 x 65 x 2

FORK CASTOR W/TOP PL. & FULL BRAKE & RUBBER TRACK

- high quality furniture fittings



STEEL FORK CASTOR W/TOP PLATE & FULL BRAKE & RUBBER TRACK

Material: Wheel: Grey soft rubber.
Metal parts: Steel, bright zinc plated.

Application: Premounted top plate.
Recommended for hard surface.
With total brake which prevents as well swivelling as turning.



Fork castor with full brake



With brake



mm

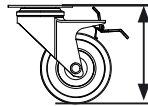

mm

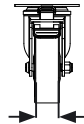

mm



static/dynamic
kg

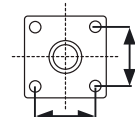

mm

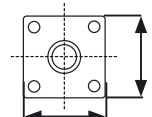

mm

08.12.167

75

100

21

60/45

45 x 45

65 x 65 x 2

Brake system in action

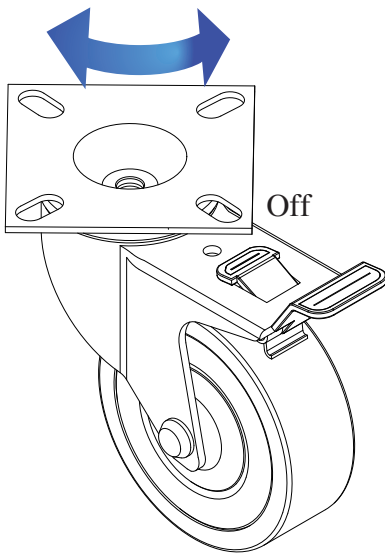

Off

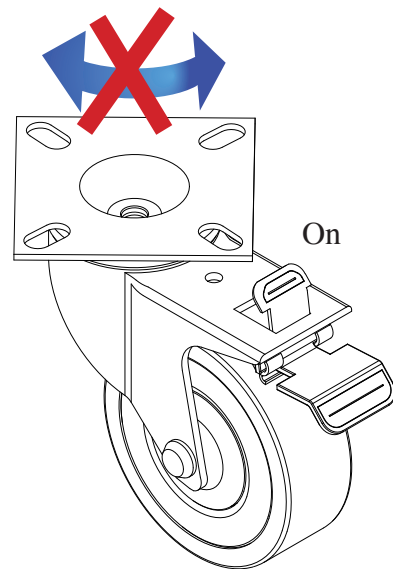
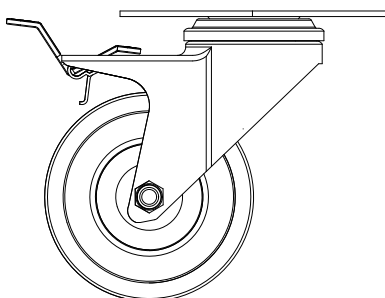

On

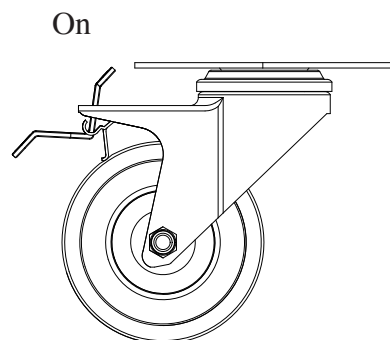

On

STEEL FORK CASTOR W/THREADED STEM & RUBBER TRACK



Material: Wheel: Grey soft rubber.
Metal parts: Steel, bright zinc plated.

Application: Premounted threaded stem in M10 x 30 mm.
Recommended for hard surface.
With or without brake.



Fork castor without brake



Fork castor with brake



No brake



mm

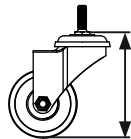

mm

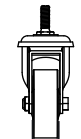

mm



static/dynamic
kg



M

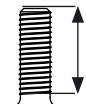

mm

08.12.165

75

98

21

60/45

M10

30



With brake



mm

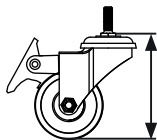

mm



mm

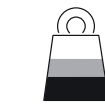

static/dynamic
kg



M

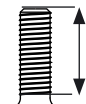

mm

08.12.166

75

98

21

60/45

M10

30

STEEL FORK CASTOR W/HOLE FOR BOLT & RUBBER TRACK

Material: Wheel: Grey soft rubber.
Metal parts: Steel, bright zinc plated.

Application: Hole for bolt.
Recommended for hard surface.
With or without brake.



Fork castor without brake



Fork castor with brake



No brake



mm

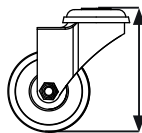

mm

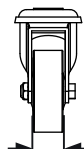

mm

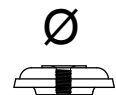
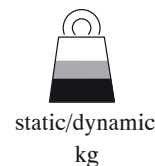

mm

# 08.12.168	50	73	18	45/30	10,5
# 08.12.170	75	100	21	60/45	10,5
# 08.12.205	100	132	25	70/55	12,5



With brake



mm

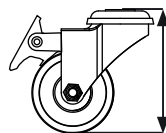

mm

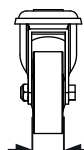

mm

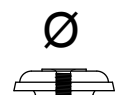
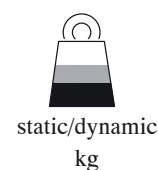

mm

# 08.12.169	50	73	18	45/30	10,5
# 08.12.171	75	100	21	60/45	10,5
# 08.12.206	100	132	25	70/55	12,5

FORK CASTOR W/FIXED PLATE & RUBBER TRACK

STEEL FORK CASTOR W/FIXED PLATE & RUBBER TRACK

Material: Wheel: Grey soft rubber.
Metal parts: 1,5 mm steel, bright zinc plated.

Application: Premounted fixed top plate.
Recommended for hard surface.
Without brake.

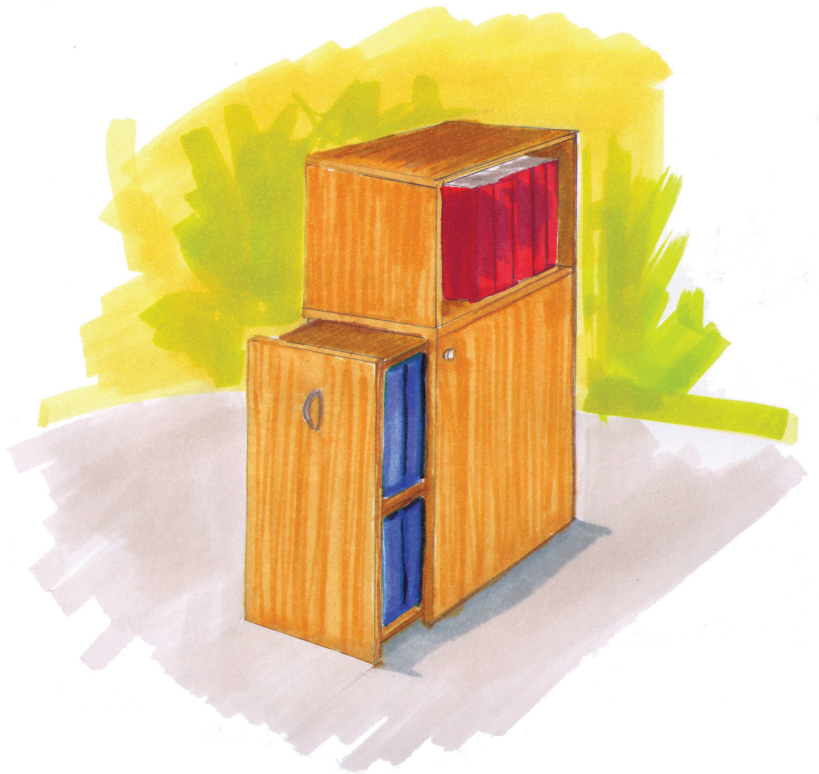

mm

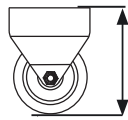

mm

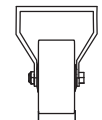

mm



static/dynamic
kg

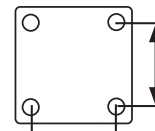

mm

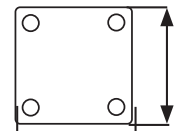

mm

08.12.150

50

73

20

45/30

30 x 30

45 x 45 x 1,5

& RUBBER TRACK

INDUSTRIAL FORK CASTOR W/SWIVEL TOP PLATE & RUBBER TRACK

Material: Wheel: Grey rubber.
Metal parts: 4 mm steel, bright zinc plated.

Application: Premounted top plate.
With or without total brake which prevents as well swivelling as turning.
Recommended for hard surface.
With or without brake.



No brake



mm

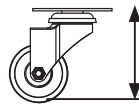

mm

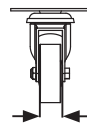

mm



static
kg

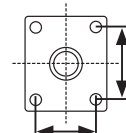

mm

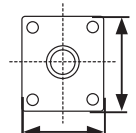

mm

08.12.210

160

198

40

150

80 x 105

110 x 135 x 4



With brake



mm



mm



mm



static
kg

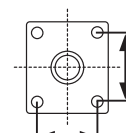

mm

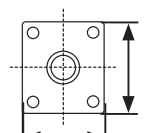

mm

08.12.211

160

198

40

150

80 x 105

110 x 135 x 4

Good advice in order to obtain optimum and correct use of your castors:

Diameter & hardness:

- Castors with large diameter roll easily and absorb possible shocks.
- Castors with wide treads (tracks) spread the load and provide good floor protection.
- Castors with hard tread (track) offer higher load capacity and roll easily.
- Castors with soft tread (track) provide a cushioned ride and a quiet operation.

What to use where?

- Castors with hard tread (track) are ideal for industrial locations with rough floors and steel grates.
- Castors with soft tread (track) protect the floor and offer a quiet operation – though, less suited for use on carpets.

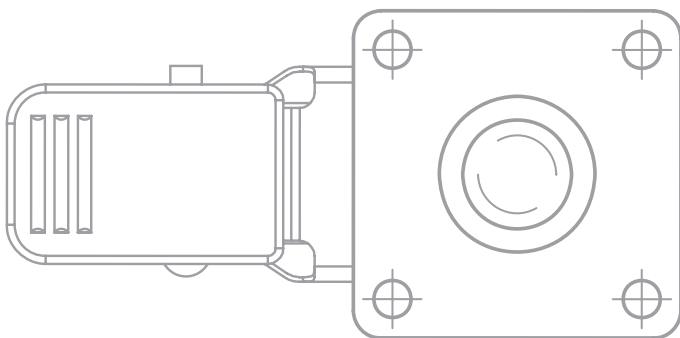
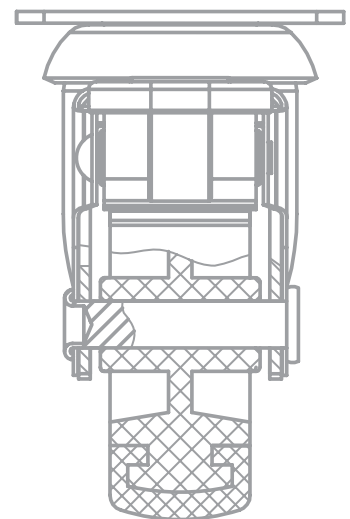
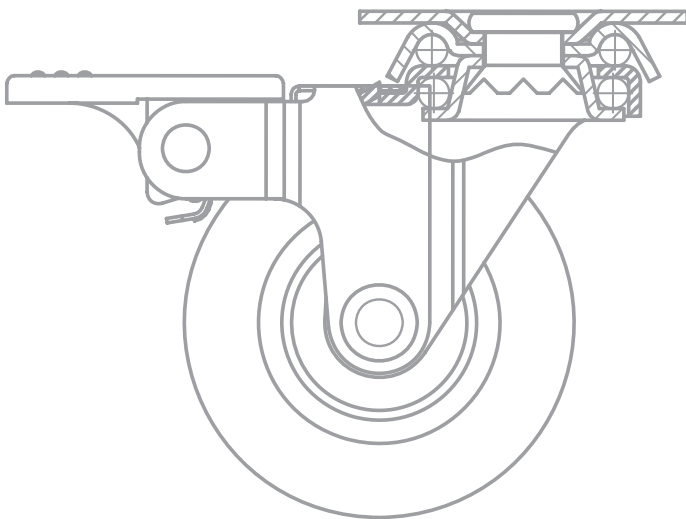

ALU LEG "JACO" W/TOP PLATE



Material: Tube: Aluminium, silver sprayed
 Plug & spacer: Plastic, black.
 Top plate: 2 mm steel, bright zinc plated.

Application: With premounted top plate 39 x 39 and 42 x 42 mm.



mm

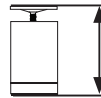

mm

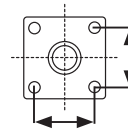

mm

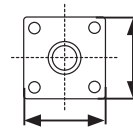

mm

# 06.09.465	40	58	29 x 29	39 x 39 x 2
# 06.09.466	40	100	29 x 29	39 x 39 x 2
# 06.09.467	40	150	29 x 29	39 x 39 x 2
# 06.09.475	60	58	32 x 32	42 x 42 x 2
# 06.09.476	60	100	32 x 32	42 x 42 x 2
# 06.09.477	60	150	32 x 32	42 x 42 x 2

ALU LEG "NIKO" W/TOP PLATE



Material: Tube: Aluminium, silver sprayed or polished.
 Plug & spacer: Plastic, black.
 Top plate: 2 mm steel, bright zinc pl.

Application: With premounted top plate 39 x 39 and 42 x 42 mm.



mm

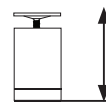

mm

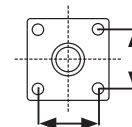

mm

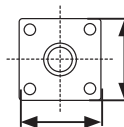

mm

Silver sprayed

Polished

# 06.09.455		40 x 40	58	29 x 29	39 x 39 x 2
# 06.09.456		40 x 40	100	29 x 29	39 x 39 x 2
# 06.09.457		40 x 40	150	29 x 29	39 x 39 x 2
# 06.09.471		60 x 60	58	32 x 32	42 x 42 x 2
# 06.09.472	# 06.09.493	60 x 60	100	32 x 32	42 x 42 x 2
# 06.09.473	# 06.09.494	60 x 60	150	32 x 32	42 x 42 x 2

ALU LEG "TRIA" & STEEL LEGS "ADRIA" & "ANDY"

ALU LEG "TRIA" W/TOP PLATE

Material: Tube: Aluminium, silver sprayed.
 Plug & spacer: Plastic, black.
 Top plate: 2 mm steel, bright zinc plated.

Application: With premounted top plate 39 x 39 mm.

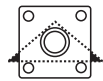

mm

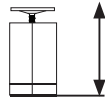

mm

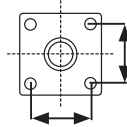

mm

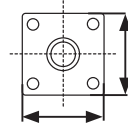

mm

# 06.09.469	40 x 40 x 55	100	29 x 29	39 x 39 x 2
# 06.09.470	40 x 40 x 55	150	29 x 29	39 x 39 x 2

STEEL LEG "ADRIA" W/THREADED STEM

Material: Leg: Steel, silver sprayed.
 Base: Plastic, black.

Application: With threaded stem M8 x 25 mm.



FINISH

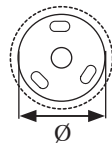

Ø

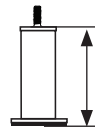

mm



Ø

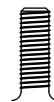

M

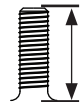

mm

# 06.09.440	Silver	35	130	55	M8	25
-------------	--------	----	-----	----	----	----

STEEL LEG "ANDY" W/ADJUSTABLE GLIDE

Material: Leg: Steel, chrome plated (CPL).
 Base: Plastic, black.

Application: With fixed top plate 61 x 61 mm.
 10 mm adjustment.



FINISH

Ø Tube

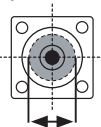

mm

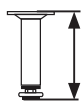

mm

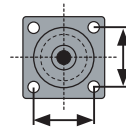

mm

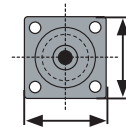

mm

# 06.09.460	CPL	30	100 to 110	46 x 46	60 x 60 x 1,5
-------------	-----	----	------------	---------	---------------

TABLE METAL LEGS W/HEIGHT ADJUSTER

- high quality furniture fittings



TABLE METAL LEGS Ø 60 X 710 MM W/HEIGHT ADJUSTER

Material:	Tube:	0,8 mm steel.
	Mounting plate:	Aluminium diecast.
	Adjustment foot:	Black plastic.
Size:		Ø60 x 710 mm.
Height adjustment:		0-25 mm.
Black painted		# 06.10.020
Chrome plated		# 06.10.022
Silver RAL 9006		# 06.10.023
SS-look (brushed nickel)		# 06.10.024
Packing:		1 set = 4 legs per box.
Other colors and sizes on request.		

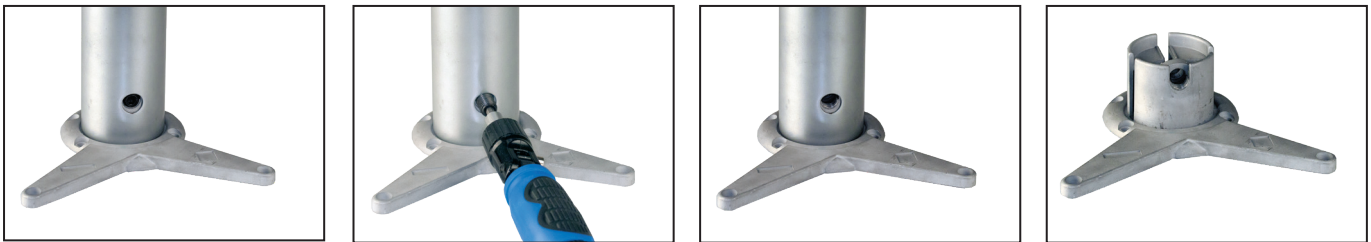

LEG BRACKET "10 DEGREE"

Material:	Steel BZP
Bolt:	M8 Bolt
Feature:	10 DG Angle
Size:	66 x 58 mm
Item. No.:	06.11.150
Application:	Fixed leg bracket in 10 degree angle

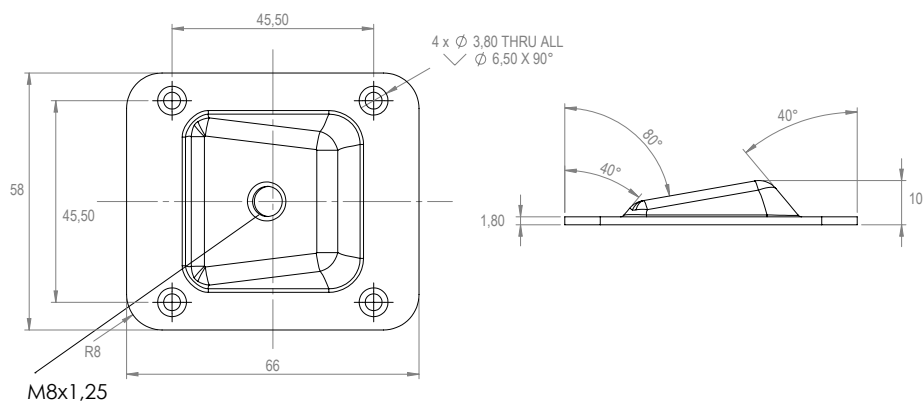

"TWISTER" - THE LEG CONNECTOR



PATENTED

"TWISTER" - LEG CONNECTOR

The "Twister" leg connector is designed for installing a leg in any position from 0 – 20 degrees – one way, simply by twisting the leg tightly onto the connector plate.

May be used on tables, cabinets, beds, sofas ect. wherever a leg is needed.

"Twister" gives the possibility to change the design on the furniture whenever there is a demand. Furthermore it may be used as a height adjuster/leveller in case of uneven floors.

Adjustable up to 40mm when changing the angle from 0 – 20 degrees. "Twister" is designed for maximum leg diameter of 50mm and M8 bolt.

The round sliding plate and body are made of black reinforced ABS. The internal part is made of steel.

Danish design by SISO & Jesper Møller Hansen.

Pat. Pending in EU & US.

Wood top mounting



(Leg: customer provided)

Glass top mounting w/aluminium disc & UV-glue

(Leg: customer provided)



"TWISTER" - THE LEG CONNECTOR

- high quality furniture fittings



WOOD TOP MOUNTING

Material: Reinforced ABS & steel
 Total size: Ø 106,5 x 27 mm
 Screw holes: Ø 5,5 mm
 Item No.: 06.11.100
 Packing: 1 pce pr. inner box
 Screws and hangerbolt to be bought separately.

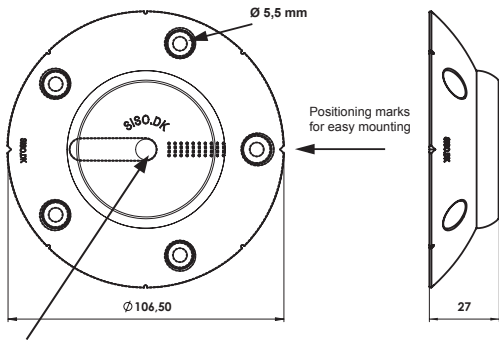
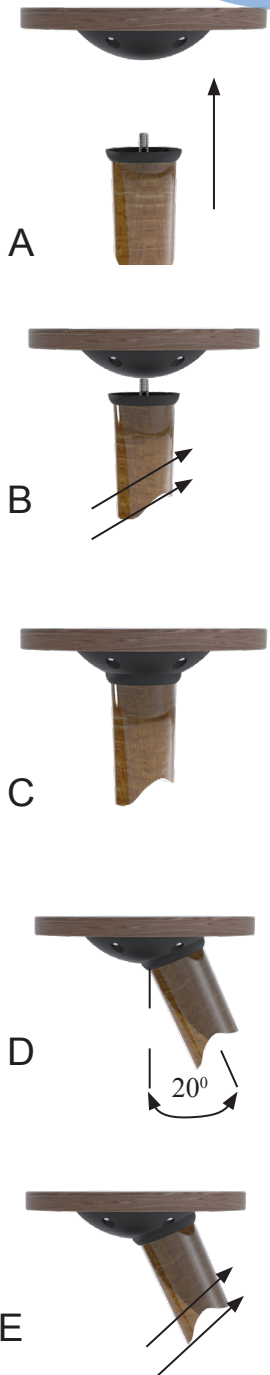

M8 thread

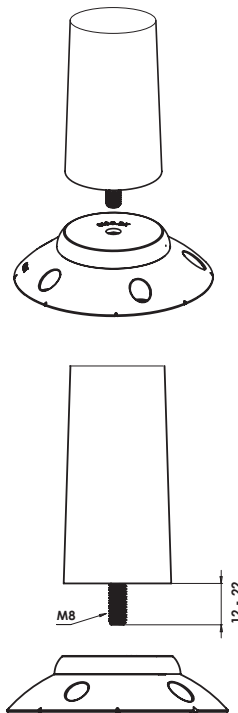
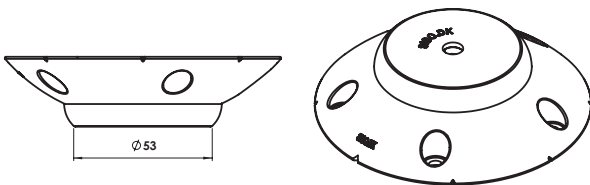

GLASS TOP MOUNTING W/ALUMINIUM DISC & UV-GLUE

For glass top mounting by use of Twister connector combined with an aluminum disc.

Material: Aluminium
 Size: Ø 108 x 10 mm,
 For screws M5 x 8mm
 Item No.: # 06.11.121

Fixing screws and Twister connector to be ordered separately.

The aluminium disc is glued to the glass by use of Bohle UV-Glue B 682-0. UV-lamp is needed.

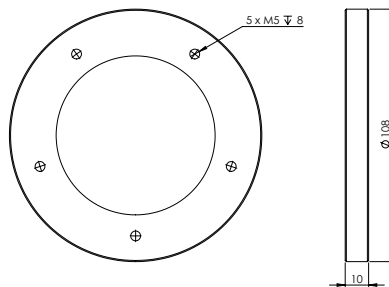

"MINI TWISTER" - THE LEG CONNECTOR

Ideal for chairs, beds, sofas and coffee tables.

Material: SS304

Total size: Ø 85 x 24 mm

Screw holes: Ø 5,5 mm

Item No.: 06.11.200, Black
06.11.201, Raw

Packing: 1 pce. per inner box

Screws and hangerbolt to be bought separately.



Stainless steel 304,
Black



(Leg: customer provided)



Stainless steel 304,
RAW



PATENTED



A



B



C

X = 0°, 6.5°, 13.5°, 20°

D

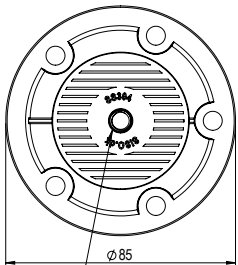

M8 thread



24

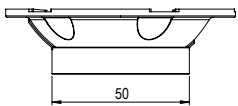
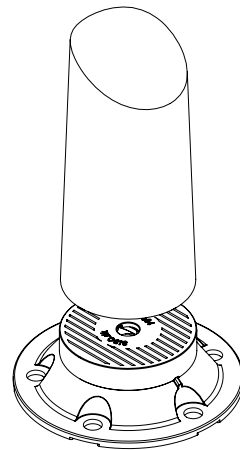

50

Preset positioning spots to insure correct adjustment and strength

- 0°
- 6,50°
- 13,50°
- 20°

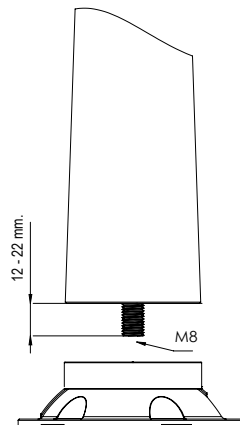

12-22 mm

M8

"TWIST 'N TURN" - THE LEG CONNECTOR

- high quality furniture fittings



"TWIST 'N TURN" - THE LEG CONNECTOR

Ideal for tables, cabinets, beds, sofas, coffee tables ect.

Feature: Adjustable in 5 steps from 0 to 15 degrees

Material: PA6 – re-inforced with glass fibre

Size: Ø 79,5 x 20 mm

Screw holes: Ø 6,2 mm

Item No.: # 06.11.130

Packing: 1 pce. per inner box

Screws and hangerbolt to be bought separately



0 degrees

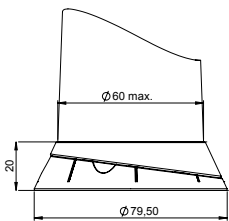

5,5 degrees

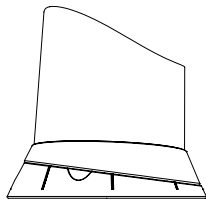

10,5 degrees

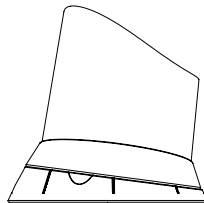

13,5 degrees

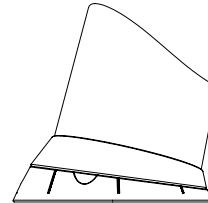

15 degrees

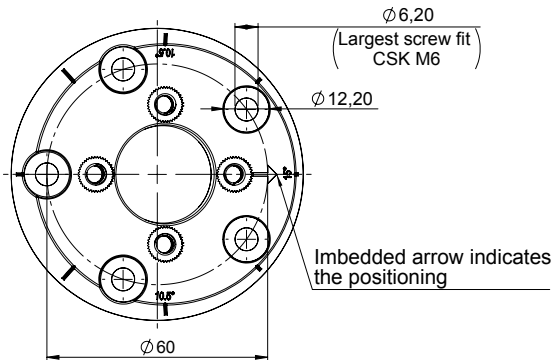
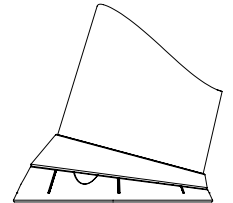

The 4 illustrated screws are included. Used to set the desired bracket angle before installing the leg

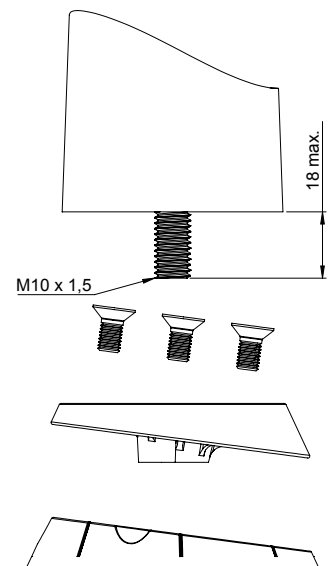
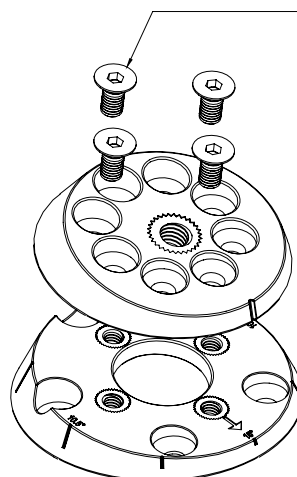

PATENTED

"RIMA" LEG CONNECTOR F/SQUARE LEGS

The "RIMA" leg connector gives you the possibility to tighten and adjust your leg in any position due to its patented internal spring-loaded system.

With a traditional bushing you normally reach a point where you cannot turn in the hangerbolt any further. If you then have a square leg that has to be flush with the edge of the furniture you have a problem. Only by heavy force you can try to turn your leg further and risk that the wood cracks.

This will not happen with the "RIMA" connector due to its patented internal spring-loaded system.



PATENTED

"RIMA" LEG CONNECTOR

Application:	F/Square Legs W/Spring Tension
Material:	Black PC/ABS
Size:	81,5 x 20,5 mm
Max. Leg size:	70 x 70 mm , F/M10 bolt
Panel thickness:	From 10 mm
Item No.:	# 06.11.140

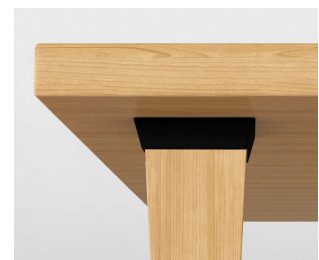
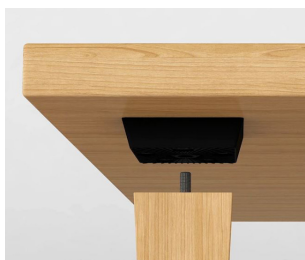
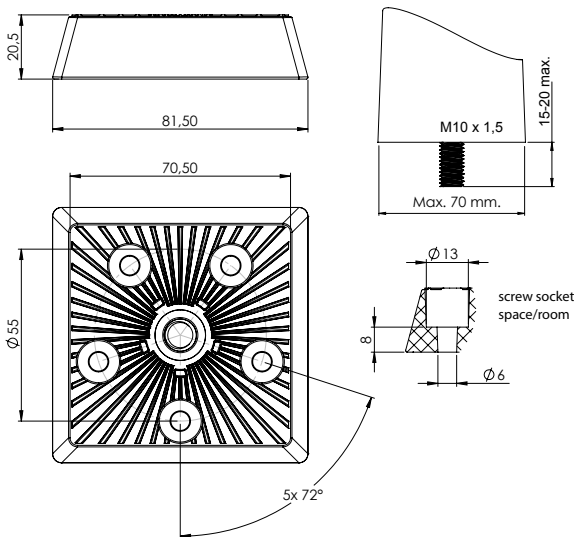
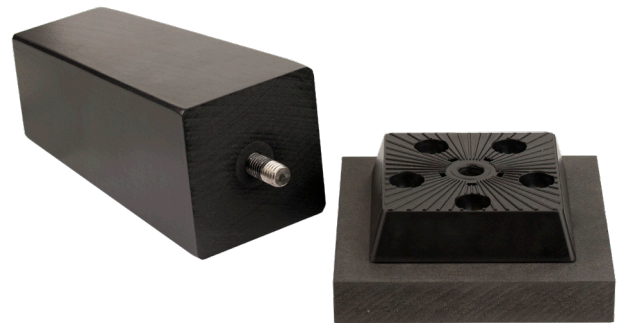

Tighten and adjust the leg to correct position without cracking the wood

ANGLE WEDGE F/"RIMA" LEG CONNECTOR

- high quality furniture fittings



ANGLE WEDGE FOR "RIMA" LEG CONNECTOR

Feature:	Adjustable in 3 steps from 0 to 10 degrees.
Material:	Black PC/ABS
Size:	81,5 x 20,5 mm, 5° angle
Item No.:	# 06.11.145



PATENTED

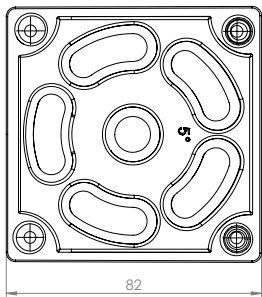
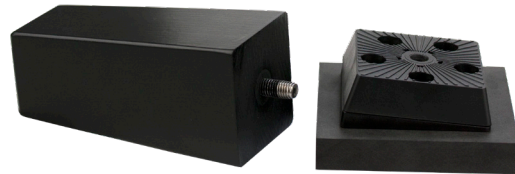

How to change the angle and direction



5° angle by use of one wedge

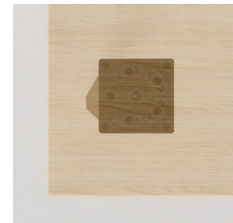

10° angle by use of two wedges

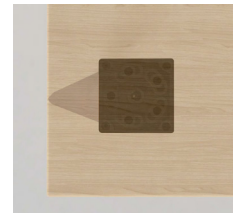

7° angle and change of direction by use of two wedges

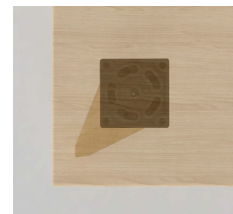
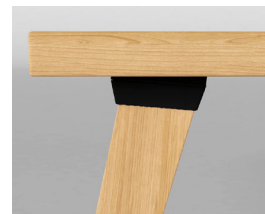

ADJUSTABLE GLIDE "ALPHA"

Material: Base: Polyamid (PA), black.
Stud: Steel, bright zinc plated.

Application: W/Knurlled edge on base.



Item - number	Finish	D diameter	H height	M size	S stud
10.16.006	Black	Ø15	6 mm	M6	22 mm
10.16.011	Black	Ø20	6 mm	M6	22 mm
10.16.016	Black	Ø20	6 mm	M6	37 mm
10.16.025	Black	Ø25	6 mm	M6	22 mm
10.16.027	Black	Ø25	6 mm	M8	22 mm
10.16.035	Black	Ø32	8 mm	M8	22 mm
10.16.040	Black	Ø38	9 mm	M8	26 mm
10.16.046	Black	Ø44	10 mm	M8	26 mm
10.16.120	Black	Ø60	10 mm	M10	34 mm

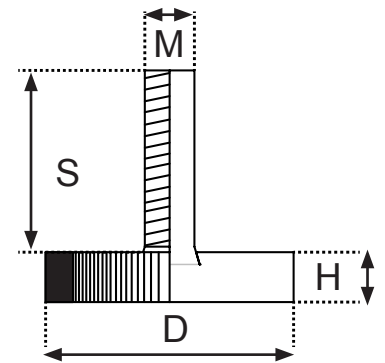

ADJUSTABLE GLIDE "MAU"

Material: Base: Polypropylene (PP), black.
Shell: Steel, zinc plated.
Stud: Steel, bright zinc plated.

Application: W/Knurlled edge on base.



Item - number	Finish	D diameter	H height	M size	S stud
#10.16.210	Black/ZP	Ø20	7 mm	M6	20 mm
#10.16.214	Black/ZP	Ø28	8 mm	M8	22 mm
#10.16.215	Black/ZP	Ø28	8 mm	M8	38 mm
#10.16.230	Black/ZP	Ø32	9 mm	M10	25 mm

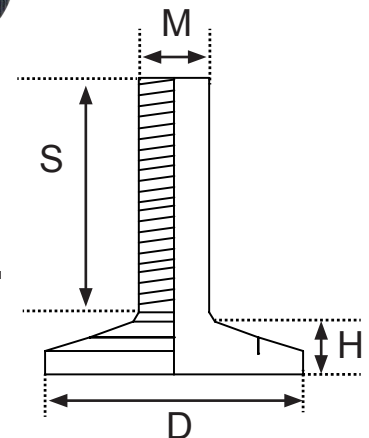

ADJUSTABLE GLIDE “VELA”

Material: Base: Polyamid (PA), black.
Stud: Steel, bright zinc plated.

Application: W/Knurled edge on base.

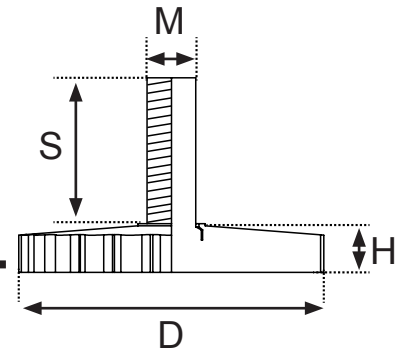

Item - number	Finish	D diameter	H height	M size	S stud
# 10.15.220	Black	Ø40	8 mm	M8	40 mm
# 10.15.250	Black	Ø50	8 mm	M8	40 mm
# 10.15.260	Black	Ø50	8 mm	M10	22 mm

ADJUSTABLE GLIDE “OCTO”

Material: Base: Polyamid (PA), black.
Stud: Steel, bright zinc plated.

Application: W/ Square hole 6x6 mm in bottom of base & 4 mm hex hole in top of the stud for quick fixing.

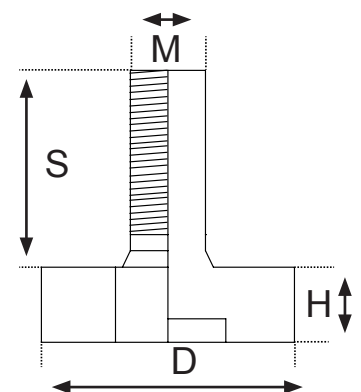

Item - number	Finish	D diameter	H height	M size	S stud
# 10.17.135	PA	27	8 mm	M8	21 mm
# 10.17.140	PA	27	9 mm	M10	35 mm

ADJUSTABLE GLIDE "BETA"

Material: Base: Polyamid (PA), black.
Stud: Steel, bright zinc plated.

Application: W/Slot in bottom of base for quick fixing.

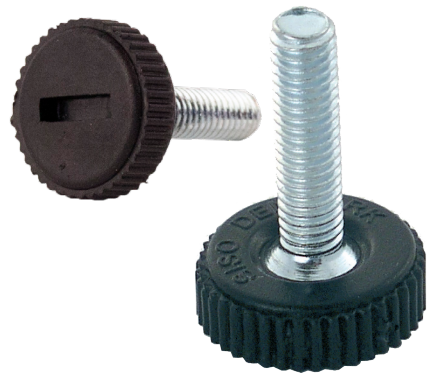

Item - number	Finish	D diameter	H height	M size	S stud
#10.17.047	Black	Ø20	7 mm	M6	6 mm
#10.17.053	Black	Ø20	7 mm	M6	22 mm

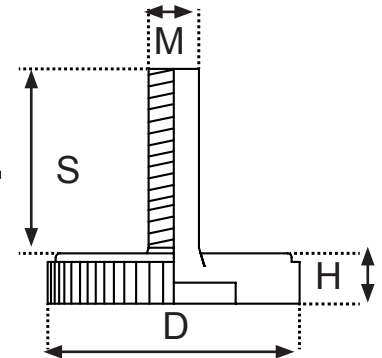

ADJUSTABLE GLIDE "SOLO"

Material: Base: Polyamid (PA), black.
Stud: Steel, bright zinc plated.

Application: W/Knurled edge & pozidriv in bottom of base for quick fixing.

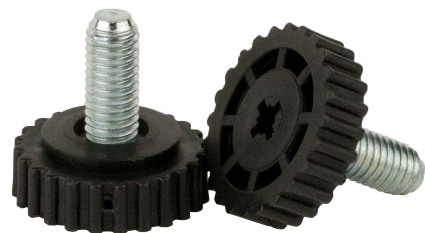

Item - number	Finish	D diameter	H height	M size	S stud
# 10.17.070	Black	Ø29	10 mm	M6	18 mm
# 10.17.071	Black	Ø29	10 mm	M8	18 mm

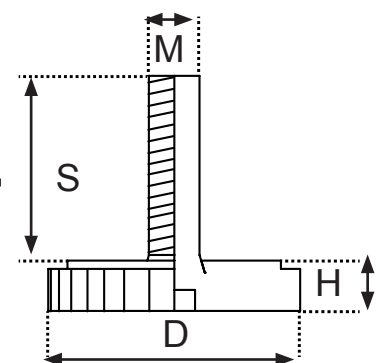

ADJUSTABLE GLIDES

- high quality furniture fittings



ADJUSTABLE GLIDE “ARC”

Material: Base: Polyamid (PA), black.
Cover shell: Steel, chrome plated.
Stud: Steel, bright zinc plated.

Application: W/Pozidriv in bottom of base for quick fixing.



10.12.400



10.12.420

Item - number	Finish	D diameter	H height	M size	S stud
# 10.12.400	Black/CPL	Ø30	12,75 mm	M8	20 mm
# 10.12.420	Black/CPL	Ø50	12,75 mm	M10	20 mm

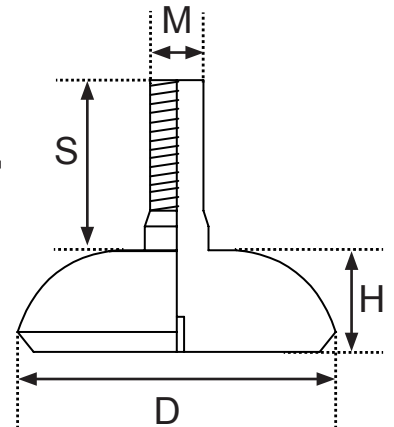

ADJUSTABLE GLIDE “JACK”

Material: Base: Polypropylene (PP), black.
Stud: Steel, bright zinc plated.

Application: W/Plastic hex nut for easy height adjustment & with pozidriv in bottom of base & in top of the stud for quick fixing.



Item - number	Finish	D diameter	H height	M size	S stud
# 10.15.050	Black	Ø25	15 mm	M8	25 mm

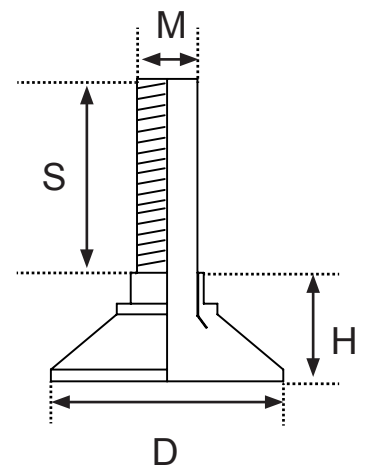

ADJUSTABLE GLIDE "TITAN"

Material: Base: Polypropylene (PP), white or black.
Shell: Steel, chrome or zinc plated.
Stud: Steel, bright zinc plated.

Application: W/Hex nut for easy height adjustment (10.12.077 without hex nut).

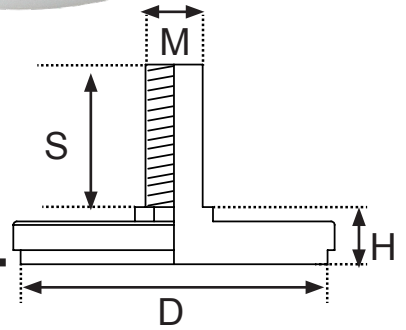
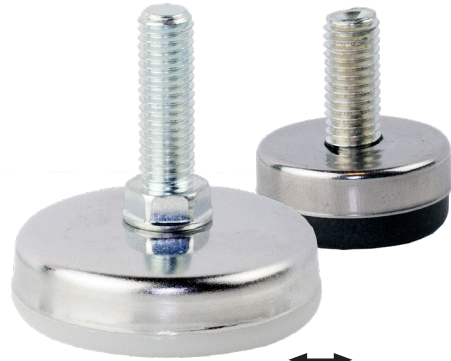

Item - number	Finish	D diameter	H height	M size	S stud
#10.12.076	White/CPL	Ø26	10 mm	M8	25 mm
#10.12.077	Black/ZPL	Ø27	11 mm	M8	18 mm
#10.12.095	White/CPL	Ø43	13 mm	M8	25 mm

ADJUSTABLE GLIDE "STRATO"

Material: Base: Polypropylene (PP), black.
Cover shell: Steel, chrome plated.
Stud: Steel, bright zinc plated.

Application: W/Hex nut for easy height adjustment.
Swivel stud for smooth leveling.

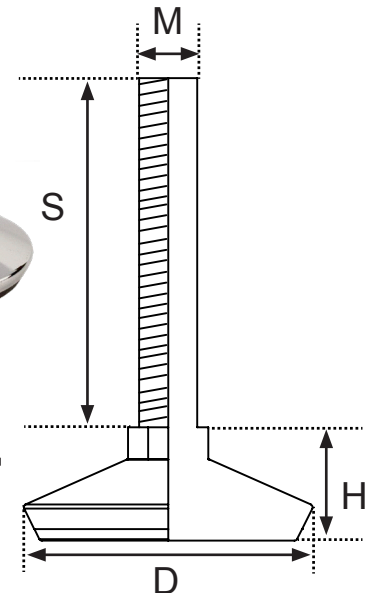

Item - number	Finish	D diameter	H height	M size	S stud
# 10.12.300	Black/CPL	Ø50	20	M10	60 mm

ADJUSTABLE GLIDE “TIME”

Material: Base: Polypropylene (PP), black.
Stud: Steel, bright zinc plated.

Application: W/Hex nut for easy height adjustment and M4 hex hole in top of the stud for quick fixing.
Swivel stud for smooth leveling.

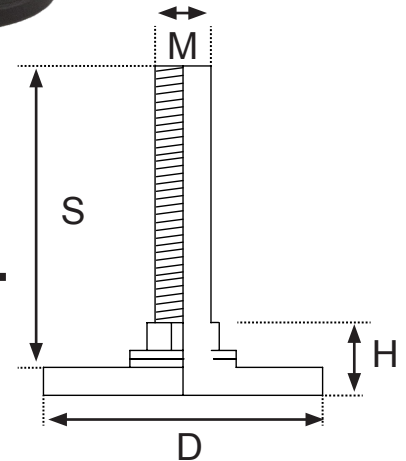

Item - number	Finish	D diameter	H height	M size	S stud
# 10.13.510	Black	Ø50	14 mm	M10	34 mm
# 10.13.520	Black	Ø50	14 mm	M10	98 mm

ADJUSTABLE GLIDE “NORFOLK”

Material: Base: Steel, nickel plated or SS-304.
Stud: Steel, bright zinc plated.
Cushion: Black rubber.

Application: W/Rubber silencer cushion for quiet working environment.

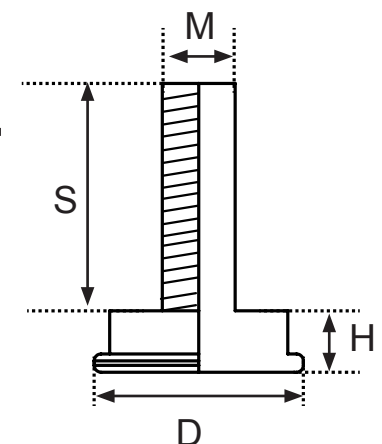

Item - number	Finish	D diameter	H height	M size	S stud
#10.21.290	Black/NPL	Ø23	10 mm	M8	25 mm
#10.21.321	Black/SS-304	Ø30	12 mm	M8	25 mm

ADJUSTABLE GLIDES

ADJUSTABLE GLIDE "CONWAY"

Material: Base: Polypropylene (PP), black.
Stud: Steel, bright zinc plated.

Application: W/Hex nut for easy height adjustment.
Oscillating stud for angle adjustment.

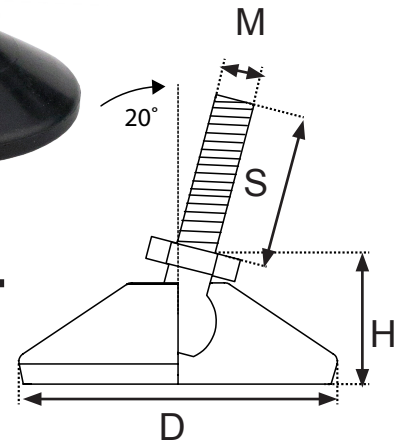

Item - number	Finish	D diameter	H height	M size	S stud
#10.08.026*	Black	Ø26	21 mm	M8	25 mm
#10.08.131	Black	Ø30	21 mm	M8	25 mm
#10.08.161	Black	Ø44	21 mm	M10	34 mm

* NO HEX NUT

ADJUSTABLE GLIDE "COLORADO"

Material: Base: Polypropylene (PP), black.
Cover shell: Steel, chrome plated.
Stud: Steel, bright zinc plated.

Application: W/Hex nut for easy height adjustment.
Oscillating stud for angle adjustment.

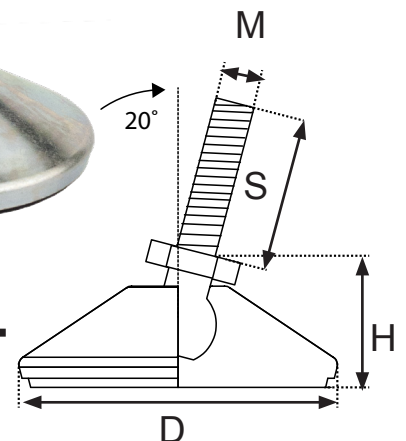

Item - number	Finish	D diameter	H height	M size	S stud
#10.08.230	Black/CPL	Ø50	22 mm	M8	25 mm
#10.08.241	Black/CPL	Ø50	22 mm	M10	34 mm

ADJUSTABLE GLIDE "COMO"

Material: Base: Steel, bright zinc plated.
Cover: Transparent polyethylene (PE).
Stud: Steel, bright zinc plated.

Application: W/Slot in top of stud for quick fixing.
Swivel stud for smooth leveling.

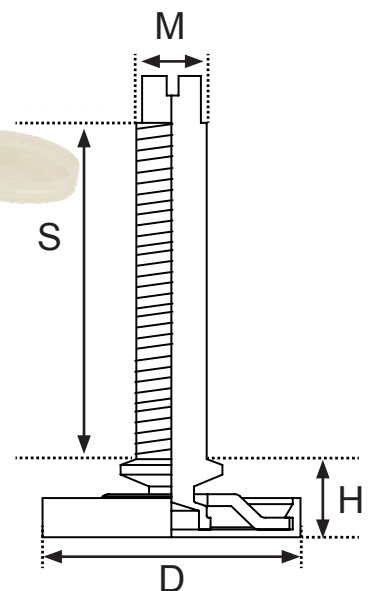

Item - number	Finish	D diameter	H height	M size	S stud
#10.16.250	BZP	Ø33	6 mm	M8	70 mm
#10.16.278	BZP	Ø33	6 mm	M10	80 mm
#10.16.279	BZP	Ø33	6 mm	M10	90 mm
#10.16.270	BZP	Ø33	6 mm	M10	100 mm

JUMBO GLIDES W/TOP PLATE

Material: Body: Polyamid (PA), chrome plated (CPL).
Base: Polyamid (PA), black.

Application: With top plate 38 x 38 mm and 42 x 42 mm.



6363



6747

5746

MODEL

FINISH

Ø Base



Ø



mm

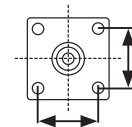

mm

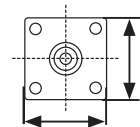

mm

# 09.01.063	# 5746	CPL	55	45	26 x 26	38 x 38 x 1,5
# 09.01.065	# 6747	CPL	68	46	26 x 26	38 x 38 x 1,5
# 09.01.066	# 6363	CPL	63	62	32 x 32	42 x 42 x 2

CUP LEVELLER W/ADJUSTABLE GLIDE

Material: Polyamid (PA), black.

Application: Knock in mounting. Ø10 mm bore.
Adjustable glide w/M4 hex hole.



Ø Cup

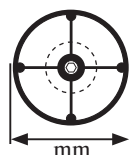

mm

Ø Glide

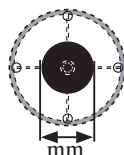

mm

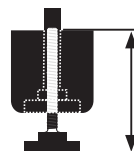

mm

Ø Bore x H

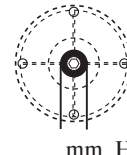

mm H= height

# 10.16.410	50	25	27 to 36	10 x 13
# 10.16.415	50	25	43 to 53	10 x 13

ADJUSTABLE GLIDES

MORTISE LEVELLER



Material: Polyamid (PA), black.
Application: Knock in mounting. Ø10 mm bore.
 Adjustable glide w/M8 hex hole.

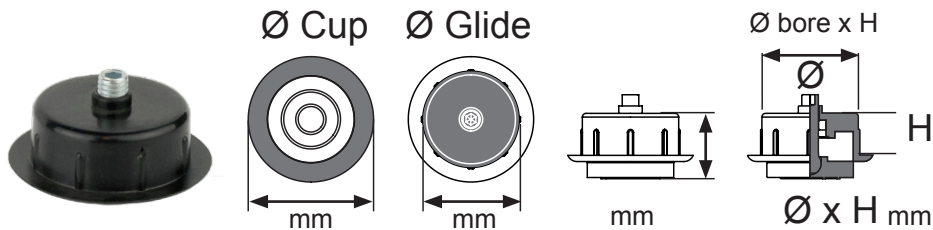

# 10.16.310	51	40	18 to 28	40 x 15
-------------	----	----	----------	---------

ADJUSTABLE CORNER BRACKET "ANGOLO"

Material: Glide: Steel, bright zinc plated.
 Bracket: Steel, bright zinc plated.
 Cover cap: Polyethylene (PE), white.

Application: W/4 mm hex hole in top of stud for quick fixing.
 Swivel stud for smooth leveling.
 W/Cover cap for floor protection.
 Left or right hand model.

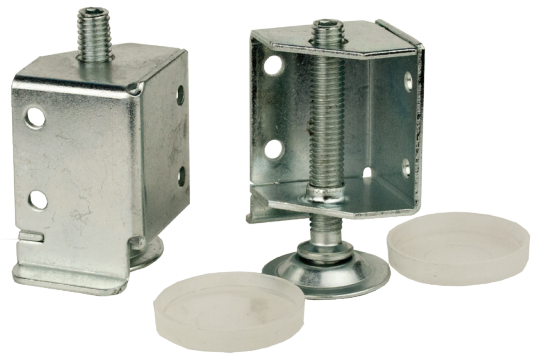

Item - number	Site L or R	D glide	H height	M size	S stud
# 10.16.510	Left	Ø32,5 x 1	1 mm	M8	60 mm
# 10.16.511	Right	Ø32,5 x 1	1 mm	M8	60 mm

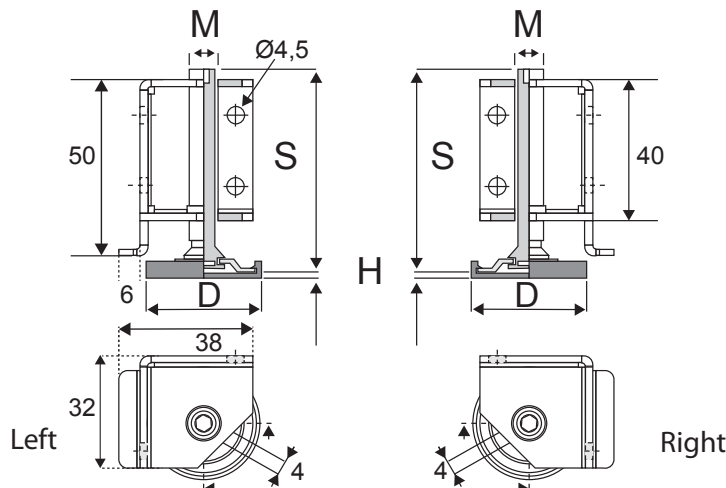

CONCEALED ADJUSTER

Material: Base: Polyamid (PA), black.
 Stud: Steel, bright zinc plated.
 Bracket: Zamak, natural.

Application: W/4mm hex hole in top of stud for quick fixing.
 Oscillating stud for angle adjustment.
 For panel thickness 18 - 30mm.
 W/fixing pin Ø5 x 9mm.

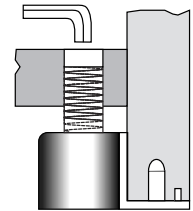
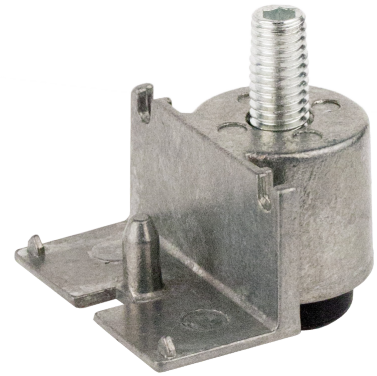

Item - number	G glide	T tread	S stud
#10.16.340	Ø20 x 9 mm	M8	32 mm

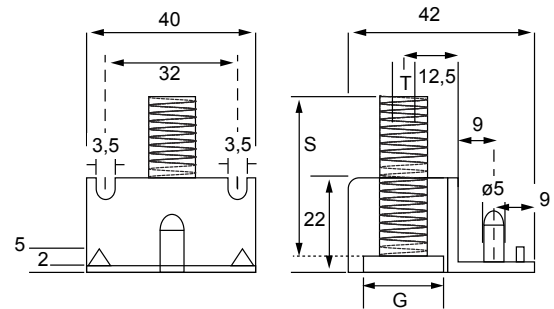

KNOCK-IN PANEL ADJUSTER

Material: Base & bracket: Polyamid (PA), black.
 Stud: Steel, bright zinc plated.

Application: W/Hex nut for easy height adjustment and slot in top of the stud for quick fixing.
 W/Knock-in pins Ø10 x 10mm, c/c: 32 mm.

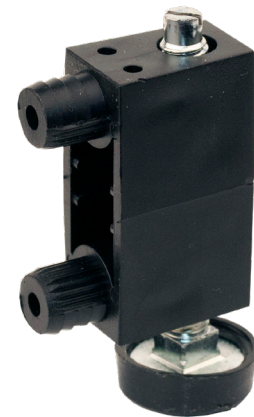

Item - number	G glide	T tread	S stud
#10.16.520	Ø23 x 8 mm	M8	60 mm

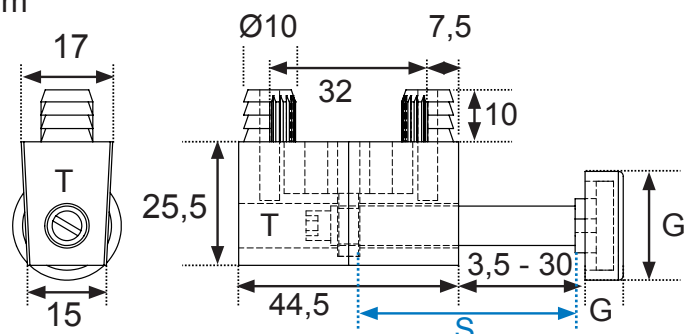

PLASTIC PANEL SHOE W/ADJUSTER

Material: Glide base: Polyamid (PA), black.
 Stud: Steel, bright zinc plated.
 Shoe body: Polyamid (PA), black.

Application: W/Knurled edge on base for smooth fixing.
 F/panel thickness 18, 25 & 28 mm.
 F/mounting on panel end only.



Item - number	Panel thickness	D glide	M size	S stud
#10.16.345	18 mm	Ø24 x 8 mm	M6	22 mm
#10.16.350	25 mm	Ø31 x 8 mm	M8	22 mm
#10.16.360	28 mm	Ø31 x 8 mm	M8	22 mm

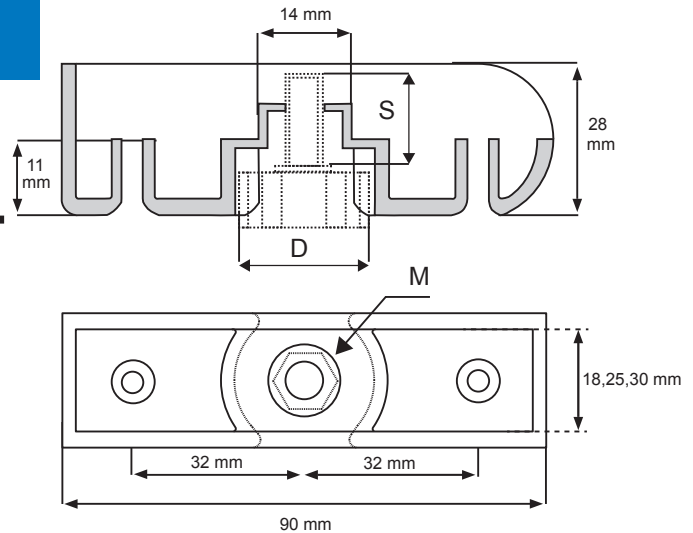

METAL PANEL SHOE "HALFMOON"

Material: Bracket: 2mm steel.
 Finish: Black or silver painted.

Application: F/panel thickness 18 mm.
 W/M6 hole for adjustable glide. Glide to be bought separately.

Adjustable Glide "Beta" item 10.17.053 is recommend.



Item - number	Color	W panel	L length	H height	S screw holes	D hole distance
#10.16.380	Silver	18 mm	58 mm	20 mm	2 x Ø4 mm	c/c: 32 mm
#10.16.381	Black	18 mm	58 mm	20 mm	2 x Ø4 mm	c/c: 32 mm

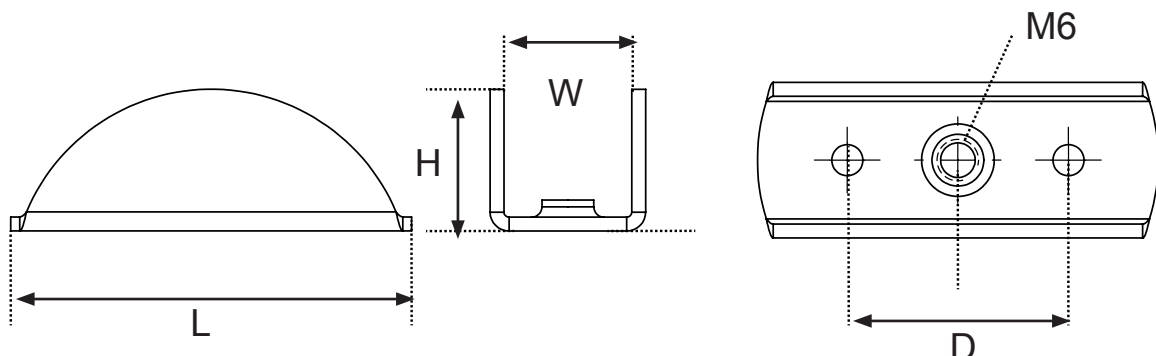

PLASTIC TACK, NAIL-ON GLIDE

Material: Base: Polyethylene, (PE), brown or white.
Nail: Steel, zinc plated.

Application: Nail-on glide with Ø2 x 15 mm nail.

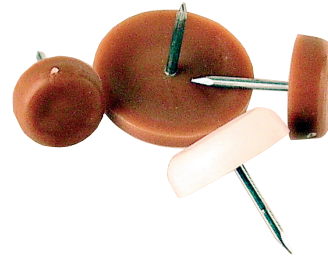

Item - number	Finish	D diameter	H height
#10.25.018	White	Ø13 mm	6 mm
#10.25.020	White	Ø15 mm	6 mm
#10.25.021	Brown	Ø15,5 mm	6 mm
#10.25.030	White	Ø18 mm	6 mm
#10.25.031	Brown	Ø18 mm	6 mm
#10.25.050	White	Ø22 mm	6 mm
#10.25.058	Brown	Ø28 mm	6 mm

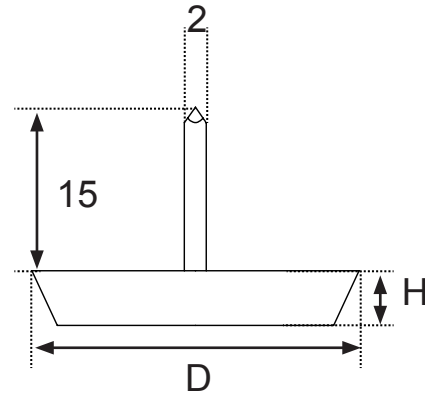

PLASTIC TACK W/FELT, NAIL-ON GLIDE

Material: Base: Polyethylene, (PE), brown or white.
Nail: Steel, zinc plated.
Felt: Grey.

Application: Nail-on glide with Ø1,6 x 13 mm nail.



Item - number	Finish	D diameter	H height	Felt - thickness
# 10.25.078	White	Ø15	8 mm	4 mm
# 10.25.079	Brown	Ø15	8 mm	4 mm
# 10.25.082	White	Ø18	8 mm	4 mm
# 10.25.083	Brown	Ø18	8 mm	4 mm
# 10.25.086	White	Ø22	8 mm	4 mm
# 10.25.087	Brown	Ø22	8 mm	4 mm
# 10.25.090	White	Ø28	8 mm	4 mm
# 10.25.091	Brown	Ø28	8 mm	4 mm

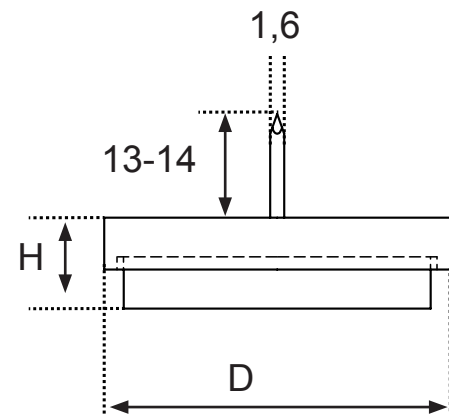

PLASTIC TACK W/FELT, SCREW-ON GLIDE

Material: Base: Polystyrol, (PS), white.
Stud: Steel, zinc plated.
Felt: Grey.

Application: Screw-on glide with Ø3,5 x 20 mm pozidriv screw.

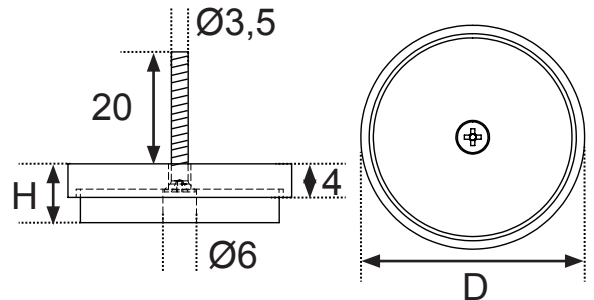

Item - number	Finish	D diameter	H height	Felt - thickness
# 10.25.100	White	Ø20	8 mm	4 mm
# 10.25.105	White	Ø24	8 mm	4 mm
# 10.25.110	White	Ø28	8 mm	4 mm
# 10.25.115	White	Ø40	8 mm	4 mm

STEEL TACK, NAIL-ON GLIDE

Material: Base: Steel, nickel plated.
Nail: Steel, zinc plated.

Application: Nail-on glide with nail.

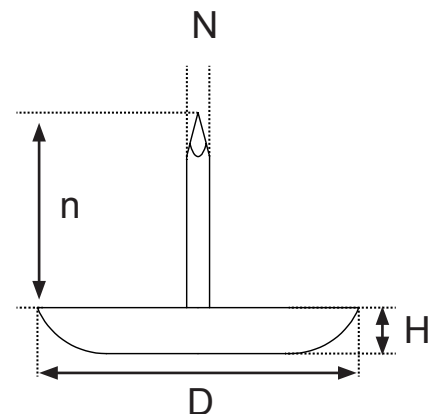

Item - number	Finish	D diameter	H height	N _{nail} diameter	n _{nail} length
# 10.22.020	NPL	Ø13	3 mm	Ø1,4 mm	12 mm
# 10.22.040	NPL	Ø15	3 mm	Ø1,4 mm	14 mm
# 10.22.050	NPL	Ø16	3,2 mm	Ø1,75 mm	14 mm
# 10.22.060	NPL	Ø18	4 mm	Ø1,75 mm	16 mm
# 10.22.070	NPL	Ø20	4 mm	Ø2 mm	18 mm
# 10.22.080	NPL	Ø23	4 mm	Ø2 mm	19 mm
# 10.22.090	NPL	Ø25	4 mm	Ø2 mm	19 mm
# 10.22.100	NPL	Ø28	5 mm	Ø2 mm	20 mm
# 10.22.110	NPL	Ø30	5 mm	Ø2 mm	20 mm
# 10.22.120	NPL	Ø35	5 mm	Ø2,5 mm	27 mm

NAIL-ON GLIDE "NORFOLK"

Material: Base: Steel, nickel plated.
 Nail: Steel, zinc plated.
 Cushion: Black rubber.

Application: W/Rubber silencer cushion for quiet working environment.
 Nail-on glide with flexible nail for angled chair legs.

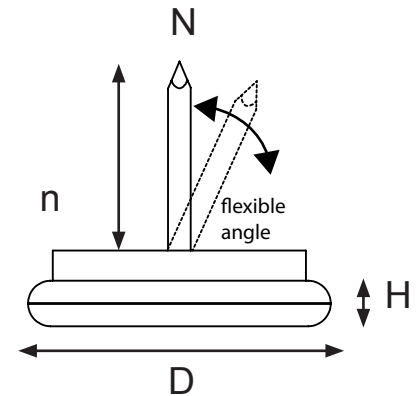

Item - number	Finish	D diameter	H height	N _{ail} diameter	n _{ail} length
# 10.21.010	NPL	Ø18	9 mm	2,4 mm	14 mm
# 10.21.020	NPL	Ø20	9 mm	2,4 mm	14 mm
# 10.21.030	NPL	Ø23	10 mm	2,4 mm	15 mm
# 10.21.040	NPL	Ø26	10 mm	2,4 mm	15 mm
# 10.21.050	NPL	Ø30	10 mm	2,4 mm	15 mm
# 10.21.060	NPL	Ø40	10 mm	3 mm	26 mm

STEEL GLIDE, W/3 PRONGS - KNOCK-IN

Material: Base: Steel, nickel plated.

Application: Knock-in glide with 3 prongs.

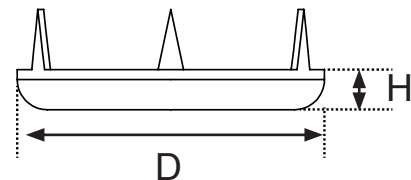

Item - number	Finish	D diameter	H height
# 10.23.010	NPL	Ø10	2,7 mm
# 10.23.020	NPL	Ø13	3,6 mm
# 10.23.030	NPL	Ø15	3,8 mm
# 10.23.040	NPL	Ø18	4,2 mm
# 10.23.050	NPL	Ø20	4,2 mm
# 10.23.060	NPL	Ø22	4,2 mm
# 10.23.070	NPL	Ø24	4,5 mm
# 10.23.080	NPL	Ø27	4,8 mm
# 10.23.090	NPL	Ø30	5,7 mm
# 10.23.100	NPL	Ø35	6,0 mm
# 10.23.110	NPL	Ø38	6,5 mm

TUBE RIVET PLASTIC GLIDE - KNOCK-IN

Material: Base: Polyethylene, (PE), white.
Rivet: Steel, zinc plated.

Application: Knock-in glide with Ø9 x 4 mm steel rivet.



Item - number	Finish	A diameter	B height	C height	D diameter
# 10.50.160	White/ZPL	Ø20	5,5 mm	4 mm	Ø9

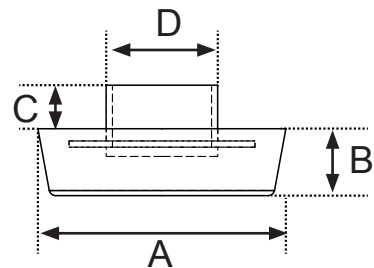

FELT PADS – SELF ADHESIVE

Material: Nonwoven fabric based on synthetic fibers, impregnated with synthetic resin in watery dispersion in order to make it solid & durable, combined with a high quality hot-melt adhesive. Available in black, white & brown.

Application: Self adhesive in round or square shape. To be used to avoid scratches on the floor.

Tip: Avoid using the felt pad for at least 24 hours after mounting to guarantee maximum adhesion.

Item - number	Color	A diameter	B height
#10.50.005	Black	Ø10 mm	1,5mm
#10.50.010	Brown	Ø16 mm	3,5 mm
#10.50.021	Brown	Ø20 mm	3,5 mm
#10.50.030	White	Ø20 mm	3,5 mm
#10.50.031	Black	Ø20 mm	3,5 mm
#10.50.035	Brown	Ø22 mm	3,5 mm
#10.50.040	Brown	Ø28 mm	3,5 mm
#10.50.041	White	Ø28 mm	3,5 mm
#10.50.060	Brown	Ø38 mm	3,5 mm
#10.50.061	Black	Ø38 mm	3,5 mm
#10.50.062	Black	Ø40 mm	3,5 mm
#10.50.073	Black	Ø55 mm	3,5 mm
#10.50.079	Black	Ø80 mm	3,5 mm
#10.50.088	Black	70 x 70 mm	1,5 mm
#10.50.093	White	10 x 130 mm	3,5 mm



*Other sizes and colors on request.

BUMPER DISCS & SUCTION PADS

- high quality furniture fittings



BUMPER DISCS – SELF ADHESIVE

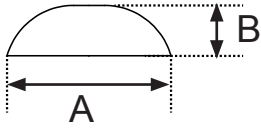

Material: PVC, transparent color.

Application: Self adhesive bumpers are the ideal solution to avoid scratching surfaces, prevent objects from skidding or vibrating, cushioning the closing of doors and drawers & equalizing height differences.

Tip: Avoid using the bumper discs for at least 24 hours after mounting to guarantee maximum adhesion.

Item - number	Color	A diameter	B height
# 10.39.010	Transparent	Ø7	1,5 mm
# 10.39.015	Transparent	Ø8	1,6 mm
# 10.39.020	Transparent	Ø10	1,5 mm
# 10.39.030	Transparent	Ø10	3,0 mm
# 10.39.040	Transparent	Ø13	4,0 mm

SUCTION PADS W/HOLLOW PIN

Material: PVC, transparent color.

Application: For glass table tops.
Hollow pin.



Item - number	A diameter	B height	C height	D diameter
# 10.38.210	Ø15	10 mm	4 mm	Ø6
# 10.38.220	Ø20	8,5 mm	6,5 mm	Ø6

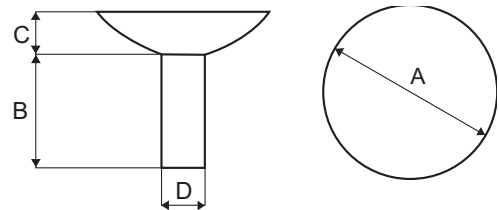

SUCTION PADS W/BALL PIN

Material: PVC, transparent color.

Application: For glass table tops.
Ball pin.

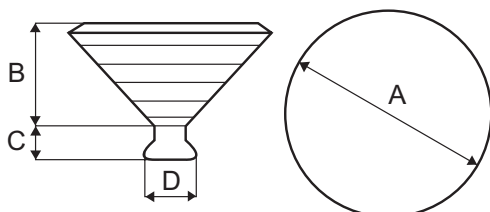

Item - number	A diameter	B height	C height	D diameter
# 10.38.310	Ø20	10 mm	4 mm	Ø6
# 10.38.312	Ø30	13 mm	5 mm	Ø8

SUCTION PADS & TUBE SLIDES

SUCTION PAD/BUMBER

Material: PVC, transparent color.

Application: For glass table tops.



Item - number	D diameter	H height	h height	d diameter
# 10.38.010	Ø8	8 mm	6 mm	4 mm
# 10.38.015	Ø14	10 mm	7 mm	8 mm

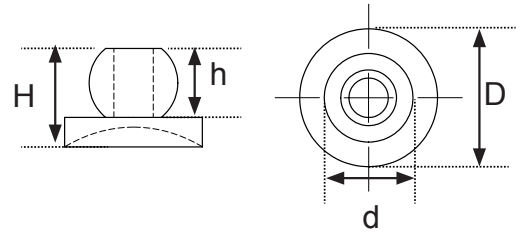

TUBE SLIDES F/CURVED TUBES - SCREW-ON

Material: Polyethylene (PE), black.

Application: For curved round tubes.
With screw holes for fixing.



Item - number	D tube	L length	B width	H height	h height	R radius	A distance	A1 distance
#10.36.010	Ø 22 mm	71 mm	23 mm	30,5 mm	6,5 mm	90	9,5 mm	42,3 mm
#10.36.015	Ø 25 mm	72,5 mm	30 mm	30,2 mm	8,3 mm	80	9,5 mm	42,3 mm
#10.36.020	Ø 32 mm	75 mm	32,5 mm	30 mm	8,3 mm	96	12 mm	28 mm
#10.36.025	Ø 38 mm	75 mm	32 mm	30 mm	8,3 mm	96	12 mm	28 mm

*Minimum quantity: 1000 pcs

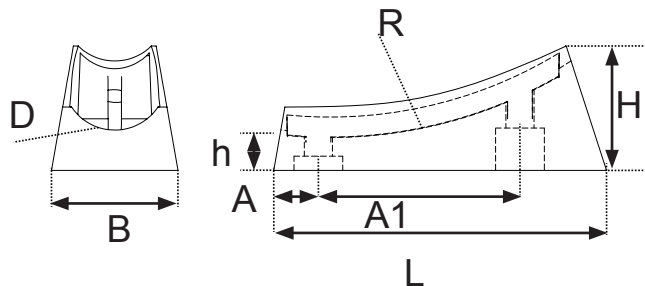

TUBE SLIDES W/FIXATION PIN

Material: Polyethylene (PE), black.

Application: For round tubes with $\varnothing 5,7$ mm. fixation pin (d).



Item - number	\varnothing tube	L length	B width	H height	S thickness
#10.34.010	$\varnothing 18-20$ mm	28,5 mm	20 mm	18 mm	4 mm
#10.34.020	$\varnothing 20-22$ mm	29 mm	22 mm	20 mm	4 mm
#10.34.030	$\varnothing 22-25$ mm	43,5 mm	23,5 mm	21,5 mm	4 mm
#10.34.040	$\varnothing 28-30$ mm	43 mm	28,5 mm	24,5 mm	4 mm
#10.34.050	$\varnothing 30-32$ mm	43 mm	29,5 mm	26 mm	4 mm
#10.34.060	$\varnothing 32-35$ mm	42,5 mm	30 mm	26,5 mm	4 mm

*Minimum quantity: 1000 pcs

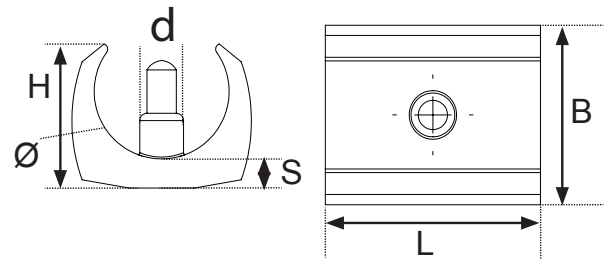

TUBE SLIDES - SCREW-ON

Material: Polyethylene (PE), black.

Application: For round tubes. With screw holes for fixing.

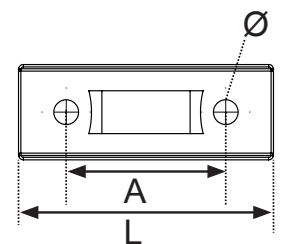
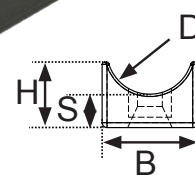

Item - number	D tube	L length	B width	H height	S thickness	\varnothing screw	A distance
#10.35.010	$\varnothing 18-22$ mm	53,5 mm	19,8 mm	13,6 mm	7 mm	2 x $\varnothing 5,2$ mm	33,5 mm
#10.35.020	$\varnothing 22-25$ mm	49,8 mm	23 mm	10,7 mm	7 mm	1 x $\varnothing 5,8$ mm	In centre
#10.35.030	$\varnothing 28-30$ mm	44,8 mm	24,8 mm	11,8 mm	7,7 mm	2 x $\varnothing 5,2$ mm	22,5 mm
#10.35.040	$\varnothing 40$ mm	49,8 mm	23 mm	10 mm	6,3 mm	1 x $\varnothing 5,5$ mm	In centre
#10.35.050	$\varnothing 45$ mm	46,5 mm	45,8 mm	17,8 mm	7,8 mm	2 x $\varnothing 6$ mm	22,5 mm

*Minimum quantity: 1000 pcs

NYLON WASHERS

Material: Polyamid (PA), natural.

Item - number	D diameter	d diameter	H height
#12.13.455	6 mm	2,5 mm	0,5 mm
#12.13.456	8 mm	4,3 mm	1,5 mm
#12.13.458	13 mm	8,6 mm	2 mm
#12.13.460	17 mm	8,6 mm	2 mm
#12.13.461	17 mm	8,4 mm	1,5 mm
#12.13.470	20 mm	10,5 mm	2 mm
#12.13.471	20 mm	13 mm	2 mm
#12.13.475	20 mm	10,5 mm	2,5 mm
#12.13.476	20 mm	10,5 mm	2,5 mm
#12.13.480	24 mm	13 mm	2,5 mm
#12.13.500	30 mm	17 mm	3 mm

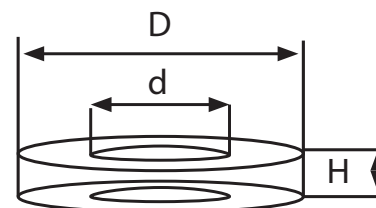

*Other sizes and colors on request.

Minimum quantity: 1000 pcs

DISTANCE SPACERS

Material: Polyethylene (PE), black or white.

Item - number	Color	D diameter	d diameter	H height
#12.13.555	Black	20 mm	5,3 mm	20 mm
#12.13.556	Black	20 mm	5,3 mm	22,5 mm
#12.13.536	Black	22 mm	6,0 mm	10 mm
#12.13.503	Black	20 mm	6,3 mm	3 mm
#12.13.508	Black	20 mm	6,3 mm	7,5 mm
#12.13.533	Black	20 mm	8,4 mm	10 mm
#12.13.538	Black	20 mm	8,4 mm	12,5 mm
#12.13.501	Black	20 mm	10,5 mm	3 mm
#12.13.507	Black	20 mm	10,5 mm	6 mm
#12.13.553	Black	20 mm	10,5 mm	20 mm
#12.13.670	White	30 mm	6,3 mm	10 mm
#12.13.554	Black	40 mm	10,5 mm	20 mm

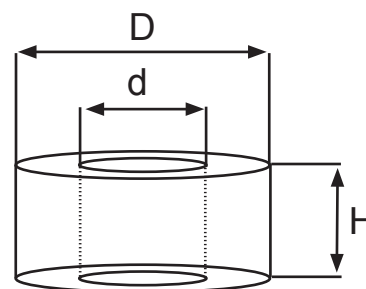

*Other sizes and colors on request.

Minimum quantity: 1000 pcs

INSERT GLIDES F/RECTANGULAR TUBES

Material: Polyethylene (PE), black.

Application: For rectangular tubes.



Item - number	Color	D diameter	S shaft	H height
#10.04.090	Black	30 x 20 mm	14 mm	5,0 mm
#10.04.110	Black	35 x 20 mm	13,6 mm	5,1 mm
#10.04.120	Black	35 x 25 mm	13,5 mm	4,6 mm
#10.04.160	Black	40 x 20 mm	13,9 mm	4,6 mm
#10.04.170	Black	40 x 25 mm	11,7 mm	4,8 mm
#10.04.230	Black	50 x 25 mm	12,2 mm	5,3 mm
#10.04.240	Black	50 x 30 mm	13,6 mm	4,6 mm
#10.04.250	Black	50 x 40 mm	12 mm	5,3 mm
#10.04.260	Black	60 x 20 mm	14,2 mm	4,9 mm
#10.04.270	Black	60 x 30 mm	13,7 mm	5,0 mm
#10.04.310	Black	80 x 30 mm	17,8 mm	5,6 mm

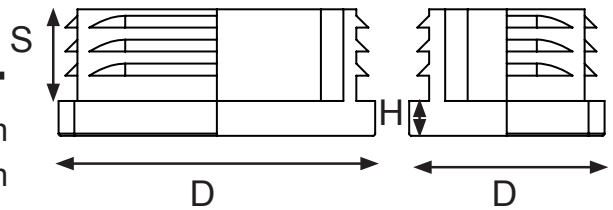

*Minimum quantity: 1000 pcs

Other sizes & colors on request.

INSERT GLIDES F/SQUARE TUBES

Material: Polyethylene (PE), black or white.

Application: For square tubes.



Item - number	Color	D diameter	S shaft	H height
#10.03.010	Black	12 x 12 mm	11,6 mm	4,0 mm
#10.03.020	Black	16 x 16 mm	12 mm	5,0 mm
#10.03.030	Black	18 x 18 mm	11 mm	5,0 mm
#10.03.050	Black	20 x 20 mm	12 mm	5,0 mm
#10.03.051	White	20 x 20 mm	12 mm	5,0 mm
#10.03.040	Black	22 x 22 mm	14 mm	5,0 mm
#10.03.060	Black	25 x 25 mm	13,5 mm	5,0 mm
#10.03.061	White	25 x 25 mm	13,5 mm	5,0 mm
#10.03.070	Black	30 x 30 mm	13,5 mm	5,0 mm
#10.03.080	Black	40 x 40 mm	14 mm	5,0 mm
#10.03.090	Black	50 x 50 mm	19 mm	5,0 mm
#10.03.100	Black	60 x 60 mm	19 mm	5,0 mm

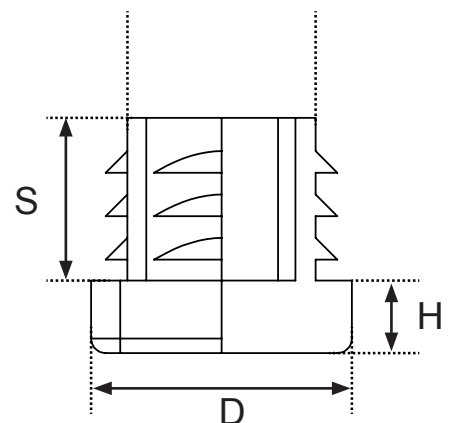

*Minimum quantity: 1000 pcs

Other sizes & colors on request.

INSERT GLIDES F/ROUND TUBES

Material: Polyethylene (PE), black or white.

Application: For round tubes.



Item - number	Color	D diameter	S shaft	H height
#10.02.030	Black	Ø14 mm	9,3 mm	4,0 mm
#10.02.040	Black	Ø15 mm	9,6 mm	4,0 mm
#10.02.070	Black	Ø19 mm	19 mm	4,1 mm
#10.02.080	Black	Ø20 mm	12 mm	4,0 mm
#10.02.090	Black	Ø22 mm	11,8 mm	4,0 mm
#10.02.100	Black	Ø25 mm	11,8 mm	5,0 mm
#10.02.101	White	Ø25 mm	11,8 mm	5,0 mm
#10.02.120	Black	Ø28 mm	14 mm	5,0 mm
#10.02.130	Black	Ø30 mm	14 mm	5,0 mm
#10.02.140	Black	Ø32 mm	14,5 mm	5,0 mm
#10.02.160	Black	Ø35 mm	14,3 mm	5,0 mm
#10.02.185	Black	Ø40 mm	11,7 mm	5,0 mm
#10.02.186	Black	Ø42 mm	11,5 mm	5,0 mm
#10.02.200	Black	Ø50 mm	11,7 mm	5,2 mm

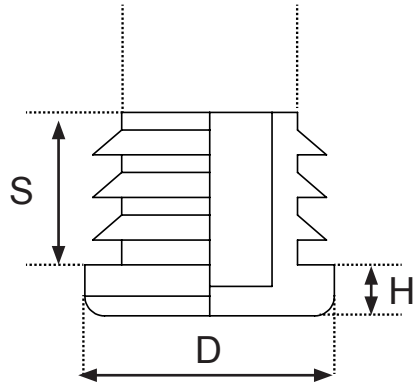

*Minimum quantity: 1000 pcs

Other sizes & colors on request.

INSERT GLIDE F/ OVAL TUBES

Material: Polyethylene (PE), black.

Application: For oval tubes.



Item - number	Color	D diameter	S shaft	H height
#10.02.400	Black	20 x 10 mm	10,5 mm	3,0 mm
#10.02.410	Black	25 x 12 mm	10,5 mm	3,0 mm
#10.02.420	Black	30 x 15 mm	16 mm	2,9 mm
#10.02.440	Black	35 x 20 mm	11,9 mm	5,3 mm
#10.02.450	Black	38 x 20 mm	11,3 mm	4,9 mm
#10.02.460	Black	40 x 20 mm	11,5 mm	4,8 mm
#10.02.480	Black	48 x 20 mm	11,5 mm	4,8 mm
#10.02.490	Black	50 x 20 mm	11,5 mm	4,8 mm

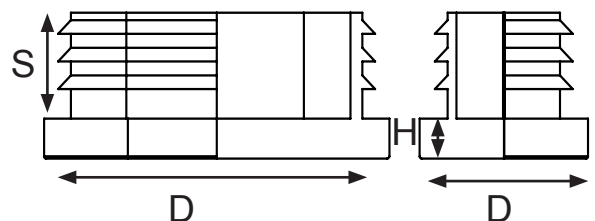

*Minimum quantity: 1000 pcs

Other sizes & colors on request.

INSERT GLIDES W/10 DG ANGLE - F/SQUARE & RECTANGULAR TUBES

Material: Polyethylene (PE), black.

Application: For square and rectangular tubes with 10 degree angle.



Item - number	Color	D diameter	S shaft	H height
#10.05.010	Black	15 x 15 mm	11,5 mm	7,2 mm
#10.05.020	Black	16 x 16 mm	12 mm	7 mm
#10.05.030	Black	18 x 18 mm	12 mm	7,8 mm
#10.05.040	Black	20 x 20 mm	12 mm	8 mm
#10.05.050	Black	20 x 15 mm	12 mm	9,3 mm
#10.05.060	Black	25 x 15 mm	12 mm	7 mm
#10.05.070	Black	25 x 25 mm	14 mm	8,5 mm
#10.05.080	Black	30 x 15 mm	12 mm	8,3 mm
#10.05.090	Black	30 x 20 mm	14,5 mm	8,5 mm

*Minimum quantity: 1000 pcs

Other sizes & colors on request.

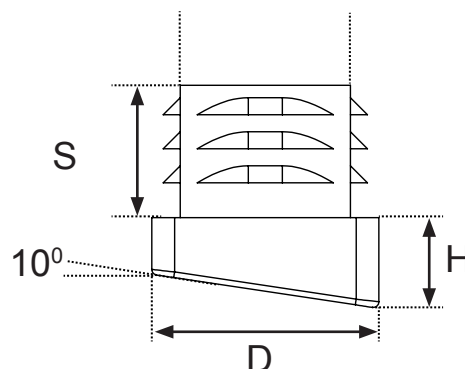

INSERT GLIDES W/METAL THREAD - F/ROUND TUBES

Material: Polyamid (PA), black.

Application: With metal thread/hex nut.
For round tubes.



Item - number	Color	D diameter	T thread	S shaft	H height
#10.06.130	Black	Ø25 mm	M8	7 mm	25 mm
#10.06.135	Black	Ø25 mm	M8	5 mm	33,5 mm
#10.06.200	Black	Ø28 mm	M8	5 mm	33,5 mm
#10.06.350	Black	Ø50 mm	M10	8 mm	25 mm

*Minimum quantity: 1000 pcs

Other sizes & colors on request.

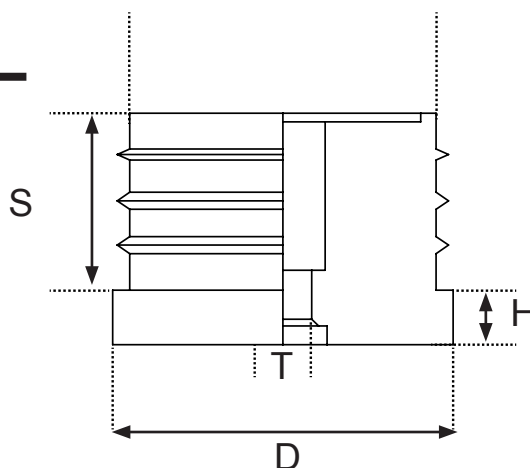

INSERT GLIDES W/METAL THREAD - F/SQUARE TUBES

Material: Polyethylene (PE), black.

Application: With metal thread/hex nut.
For square tubes.



Item - number	Color	D diameter	T thread	S shaft	H height
#10.07.065	Black	20 x 20 mm	M8	14,2 mm	6 mm
#10.07.080	Black	25 x 25 mm	M8	13,6 mm	7 mm
#10.07.081	Black	30 x 30 mm	M10	12,8 mm	8 mm
#10.07.082	Black	40 x 40 mm	M10	13,2 mm	8 mm

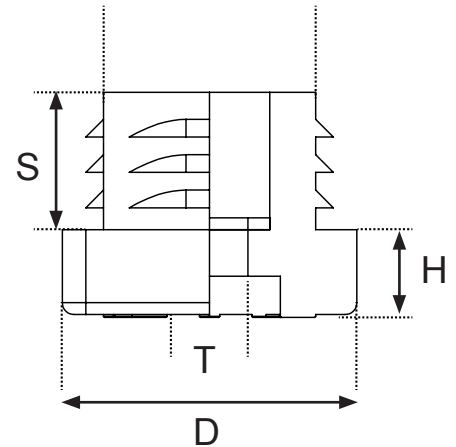

*Minimum quantity: 1000 pcs

Other sizes & colors on request.

PLASTIC CAPS F/ROUND TUBES

Material: Polyethylene (PE), black or white & PVC, black.

Application: For round tubes.

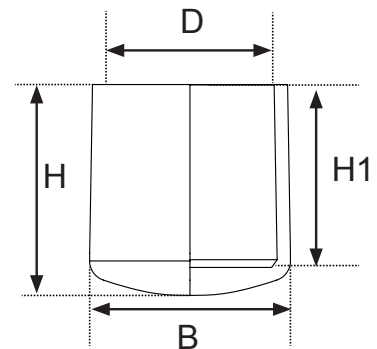

Item - number	Color	Material	D diameter	B diameter	H height	H1 height
#10.01.010	Black	PE	Ø10 mm	Ø13,4 mm	14,6 mm	12,1mm
#10.01.020	Black	PE	Ø13 mm	Ø16,5 mm	18 mm	14 mm
#10.01.030	Black	PE	Ø16 mm	Ø19,7 mm	21,2 mm	17 mm
#10.01.040	Black	PE	Ø18 mm	Ø22,3 mm	23,2 mm	19,2 mm
#10.01.050	Black	PE	Ø20 mm	Ø24,2 mm	23,3 mm	18,9 mm
#10.01.060	Black	PE	Ø22 mm	Ø27,6 mm	24,1 mm	20,1 mm
#10.01.070	Black	PE	Ø25 mm	Ø28,1 mm	30,6 mm	24,8 mm
#10.01.071	White	PE	Ø25 mm	Ø28,1 mm	30,6 mm	24,8 mm
#10.01.080	Black	PE	Ø28 mm	Ø32,8 mm	28,8 mm	23,9 mm
#10.01.090	Black	PVC	Ø32 mm	Ø36 mm	30,8 mm	25,5 mm
#10.01.100	Black	PVC	Ø35 mm	Ø39 mm	31,2 mm	25 mm
#10.01.120	Black	PVC	Ø42 mm	Ø46 mm	33 mm	24 mm

*Minimum quantity: 1000 pcs



- high quality furniture fittings

Item No.: 99.00.032

14.06.2018

SISO A/S

Mileparken 11 Phone: (+45) 45 830 900
DK - 2740 Skovlunde (Copenhagen) Fax: (+45) 45 830 444
Denmark E-mail: siso@siso.dk Web: www.siso.dk